

# TM 11-5820-398-12

DEPARTMENT OF THE ARMY TECHNICAL MANUAL

---

OPERATOR AND ORGANIZATIONAL MAINTENANCE MANUAL  
INCLUDING REPAIR PARTS AND  
SPECIAL TOOLS LISTS

## RADIO SET AN/PRC-25

(NSN 5820-00-857-0759)

(INCLUDING RECEIVER-TRANSMITTER  
RADIO RT-505/PRC-25)

(5820-00-857-0934)

This copy is a reprint which includes current  
pages from Changes 1 through 6.

---

HEADQUARTERS, DEPARTMENT OF THE ARMY  
NOVEMBER 1965

**CONDENSED OPERATING INSTRUCTIONS  
FOR RADIO SET AN/PRC-25**

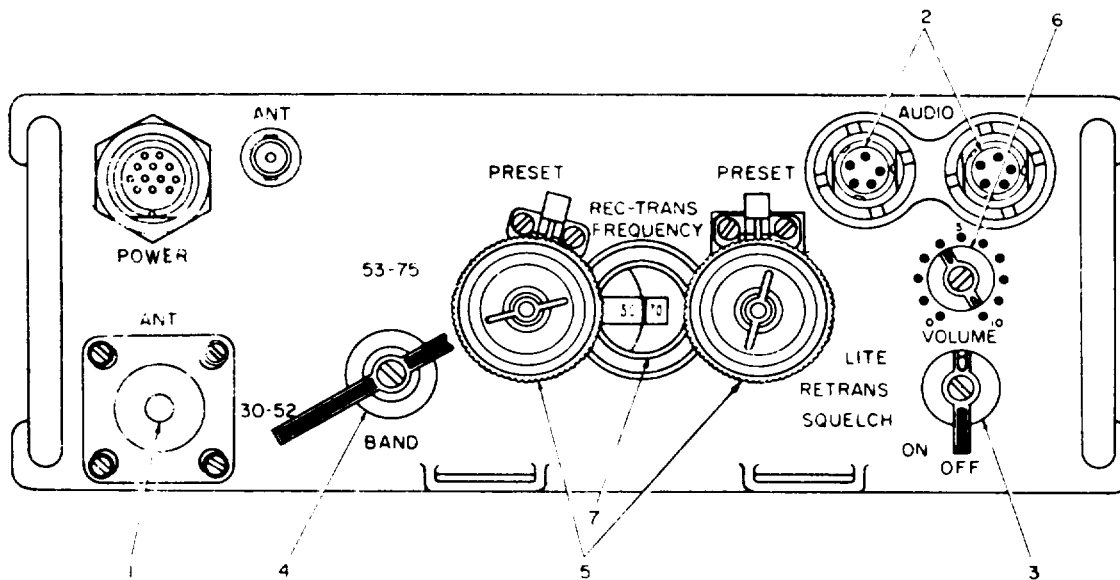

**TO OPERATE SET**

A THE NUMBERS OF STEPS I THROUGH 6 BELOW RELATE TO THE NUMBERS ON THE DIAGRAM

- (1) INSTALL THE ANTENNA REQUIRED FOR THE TYPE OF OPERATION IN THE ANT MOUNT
- (2) ATTACH HANDSET H-138/U TO EITHER AUDIO CONNECTOR.
- (3) TURN THE FUNCTION SWITCH TO ON,
- (4) TURN THE BANO SWITCH TO THE DESIRED OPERATING FREQUENCY BAND,
- (5) TURN THE MC TUNING AND KC TUNING CONTROL KNOBS UNTIL THE DESIRED FREQUENCY APPEARS IN THE CHANNEL DIAL (7).
- (6) TURN THE VOLUME CONTROL TO 4.
- (7) PRESS THE HANDSET H-138/U PUSH-TO-TALK SWITCH AND SPEAK INTO HANDSET. RELEASE THE PUSH-TO-TALK SWITCH TO LISTEN.
- (8) ADJUST THE vOLUME CONTROL (6) FOR A DESIRABLE SOUND LEVEL,
- (9) TO REDUCE THE RUSHING NOISE WHEN NO SIGNAL IS BEING RECEIVED, TURN SWITCH (3) TO SQUELCH,

**TO TURN SET OFF**

B. TURN THE FUNCTION SWITCH (3) TO OFF.

TM5820-398-10-12

Figure A. Condensed operating instructions for Radio Set AN/PRC-25

HEADQUARTERS  
DEPARTMENT OF THE ARMY  
WASHINGTON, DC, 1 JANUARY 1988

CHANGE }  
N O . 6 }

**Operator's and Organizational Maintenance Manual  
including Repair Parts and Special Tools Lists**

**RADIO SET AN/PRC-25 (NSN 5820-00-857-0759)  
(INCLUDING RECEIVER-TRANSMITTER, RADIO  
RT-505/PRC-25 (5820-00-857-0934))**

TM 11-5820-398-12, 17 November 1965, is changed as follows:

1. Title of the manual is changed as shown above.
2. Remove old pages and insert new pages as indicated below. New or changed material is indicated by a vertical bar in the margin of the page. Added or revised illustrations are indicated by a vertical bar adjacent to the identification number.

None	A and B
1-1 and 1-2	1-1 and 1-2
2-1 and 2-2	2-1 and 2-2
4-5 and 4-6	4-5 and 4-6
5-1 and 5-2	5-1 and 5-2
6-3 and 6-4	6-3 and 6-4
None	6-4.1 /(8-4.2 blank)
6-9 and 6-10	6-9 and 6-10
F-1 and F-2	F-1 and F-2

3. File this change sheet in front of the publication for reference purposes.

**Distribution authorized to the Department of Defense and DOD contractors only for official use or for administration or operational purposes. This determination was made on 10 October 1987. Other requests for this document will be referred to Commander, US Army Communications-Electronics Command and Fort Monmouth, ATTN: AMSEL-ME-P, Fort Monmouth, NJ 07703-5000.**

**DESTRUCTION NOTICE - Destroy by any method that will prevent disclosure of contents or reconstruction of the document.**

By Order of the Secretary of the Army:

CARL E. VUONO  
*General, United States Army*  
*Chief of Staff*

Official:

R.L. DILWORTH  
*Brigadier General, United States Army*  
*The Adjutant General*

**DISTRIBUTION:**

To be distributed in accordance with DA Form 12-51 literature requirements for AN/PRC-25.

CHANGE }  
N O . 5 }

HEADQUARTERS  
DEPARTMENT OF THE ARMY  
WASHINGTON, DC, 22 *January* 1979

**Operator's and Organizational Maintenance Manual  
Including Repair Parts and Special Tools Lists  
RADIO SET AN/PRC-25 (NSN 5820-00-857-0759)  
(INCLUDING RECEIVER-TRANSMITTER, RADIO  
RT-505/PRC-25 (5820-00-857-0934))**

TM 11-5820-39%12, 17 November 1965, is changed as follows:

1. The title of the manual is changed to read as indicated above.
2. Changed material is indicated by a bar in the margin. New chapters, paragraphs and appendixes are indicated by a bar in the caption.
3. Remove and insert pages as indicated below:

<i>Remove pages</i>	<i>Insert pages</i>
i through iii.....	i and ii
1-1 through 1-2.1.....	1-1 through 1-2.1
2-1 through 2-4.....	2-1 through 2-4
3-1 through 3-4.....	3-1 through 3-4
4-1 through 4-3.....	4-1 through 4-6
5-1 through 5-5.....	5-1 through 5-6
6-9 through 6-12.....	6-9 through 6-12
6-15 and 6-16.....	6-15 and 6-16
7-1 and 7-2.....	7-1
A-I-1 and A-I-2.....	A-1 and A-2
All-1 and All-2.....	B-1 and B-2
AIV-3 through AIV-6.....	.....
.....	E-1 and E-2
.....	F-1 and F-2

4. File this change sheet in the front of the manual for reference purposes.

By Order of the Secretary of the Army:

**BERNARD W. ROGERS**  
*General, United States Army*  
*Chief of Staff*

Official:

**J. C. PENNINGTON**  
*Brigadier General, United States Army*  
*The Adjutant General*



**HEADQUARTERS,**  
DEPARTMENT OF THE ARMY  
WASHINGTON DC, 20 August, 1974

**Operator's and Organizational Maintenance Manual  
Including Repair Parts and Special Tools Lists  
RADIO SET AN/PRC-25  
(INCLUDING RECEIVER-TRANSMITTER, RADIO RT-505/PRC-25)**

TM 11-5820-398-12, 17 November 1965, is changed as follows:

1. A vertical bar appears opposite changed material:
2. Remove and insert pages as indicated in the page list below:

<i>Remove Pages</i>	<i>Insert Pages</i>
<i>f and ii</i>	<b>i through iii</b>
<i>1-1 and 1-2</i>	<b>1-1 through 1-2.1</b>
<i>AII-1 through AII-4</i>	<b>AII-1 through AII-2</b>

3. **File this change sheet in the front of the manual for reference purposes.**

By Order of the Secretary of the Army:

Official:

VERNE L. BOWERS  
*Major General, United States Army  
The Adjutant General*

CREIGHTON W. ABRAMS  
*General, United States Army  
Chief of Staff*

Distribution:

To be distributed in accordance with FA Form 12-51, Operator maintenance requirements for AN/GRC-125, AN/PRC-25 and AN/VRC-53.





CHANGE }  
No. 3 }

HEADQUARTERS  
DEPARTMENT OF THE ARMY  
WASHINGTON, D. C. 10 October 1970

**Operator and Organizational Maintenance Manual  
Including Repair Parts and Special Tool Lists**

**RADIO SET AN/PRC-25  
(INCLUDING RECEIVER-TRANSMITTER, RADIO RT-505/PRC-25)**

TM 11-5820-398-12, 17 November 1965, is changed as follows:

1. The title of the manual is changed as indicated above.

2. Remove and insert pages as indicated below:

Remove	insert
i and ii	i and ii
1-1 through 1-4	1-1 through 1-4
2-1 through 2-4	2-1 through 2-4
3-1 through 3-8	3-1 through 3-8
4-1 through 4-3	4-1 through 4-3
5-1 through 5-11	5-1 through 5-6
6-1 through 6-4	6-1 through 6-4
6-13 and 6-14	6-13 and 6-14
6-19 and 6-20	6-19 and 6-20
6-25 (fig. 6-17)	6-25 (fig. 6-17)
AI-1 and AI-2	AI-1 and AI-2
AII-1 through AII-4	AII-1 through AII-4
AIII-1 through AIII-8	AIII-1 through AII-6
AIV-1 through AIV-11	AIV-1 through AIV-10

3. Page 2 of cover.

A (2). Delete H-138/U.

A (7). Delete H-138/U,

4. File this change sheet in front of the publication for reference purposes.

By Order of the Secretary of the Army:

W. C. WESTMORELAND,  
*General, United States Army,*  
*Chief of Staff.*

Official:

KENNETH G. WICKHAM,  
*Major General, United States Army,*  
*The Adjutant General.*

Distribution:

To be distributed in accordance with DA Form 12-51, organizational maintenance requirements for AN/GRC-125, AN/PRC-25, and AN/VRC-53 radio sets.



CHANGE }  
NO. 2 }

HEADQUARTERS  
DEPARTMENT OF THE ARMY  
WASHINGTON, D. C., 23 October 1968

**Operator and Organizational Maintenance Manual**  
**Including Repair Parts and Special Tool Lists**  
**RADIO SET AN/PRC-25**

TM 11-5820498-12, 17 November 1965, is changed as follows:

1. Remove old pages and insert new pages as indicated below.

Remove pages	Insert pages
iand ii	iand ii
1-1 through 1-3	1-1 through 1-5
2-5	2-5 and 2-6
3-3 through 3-5	3-3 through 3-8
5-3 through 5-5	5-3 through 5-11
6-1 through 6-9	6-1 through 6-25
AI-1	AI-1 through AI-2
AII-1 through AII-3	AII-1 through AII-4
AIII-3 through AII-8	AIII-3 through AIII-8
	<i>Insert figure</i>
	7-2 (fold-in)

2. File this change sheet in front of the publication for reference purposes.

By Order of the secretary of the Army:

Official:

KENNETH G. WICKHAM,  
Major General, United States Army,  
The Adjutant General.

W. C. WESTMORELAND,  
General, United States Army,  
Chief of Staff.

Distribution:

To be distributed in accordance with DA Form 12-51 (qty rqr Block #326) requirements for Organizational maintenance, AN/PRC-25 Radio Set.



CHANGES }  
 N O . 1 }

HEADQUARTERS,  
 DEPARTMENT OF THE ARMY  
 WASHINGTON, D. C., 29 September 1966

## Organizational Maintenance Manual

Including Repair Parts and Special Tool Lists

### RADIO SET AN/PRC-25

TM 11-5820-398-12, 17 November 1965, is changed to add technical information.

1. Remove and insert pages as indicated below.

Remove pages  
 AIV-3 and AIV-4

Insert pages  
 AIV-3 through AIV-11

2. Retain this transmittal sheet in the front of the manual for future reference.

By Order of the Secretary of the Army:

HAROLD K. JOHNSON,  
*General, United States Army,*  
*Chief of Staff.*

Official:

KENNETH G. WICKHAM,  
*Major General, United States Army,*  
*The Adjutant General.*

Distribution:

#### Active Army

USASA (2)  
 CNGB (1)  
 OCC-E (7)  
 Dir of Trans (1)  
 CofEngrs (1)  
 TSG (1)  
 CofSptS (1)  
 USAARENBD (2)  
 USAAESWBD (5)  
 USAAVNTBD (5)  
 USAIB (5)  
 USACDCEA (1)  
 USACDCCBRA (1)  
 USACDCCEA (1)  
 USACDCCEA Ft Huachuca (1)  
 USACDCOA (1)  
 USACDCQMA (1)  
 USACDCTA (1)  
 USACDCADA (1)  
 USACDCARMA(1)  
 USACDCAVNA (1)  
 USACDCARTYA(1)  
 USACDCSWA (1)  
 USAMC (5)  
 USCONARC (5)

ARADCOM (5)  
 ARADCOM Rgn (2)  
 OS Maj Comd (4)  
 USACSS (5)  
 LOGCOMD (2)  
 USAMICOM (4)  
 USASTRATCOM (4)  
 USASTRATCOM-EUR (10)  
 USARYIS (5)  
 USAREUR (5)  
 USAESC (85)  
 USACOMZEUR (5)  
 MDW (1)  
 Armies (2) except  
   USARAL (8)  
   7th USA (8)  
   8th USA (8)  
 corps (2)  
 USAC (3)  
 1st GM Bde (5)  
 9th USASA Fld Sta (5)  
 12th USASA Fld Sta (5)  
 Svc Colleges (2)  
 USASOS (5)

U S A S E S C S ( 6 0 )

USAADS (2)	1-59	6-435
USAAMS (30)	1-75	6-445
USAARMS (30)	1-76	6-449
USAIS (30)	1-77	6-501
USAES (2)	1-78	6-525
MFSS (5)	1-100	6-536
USMA (5)	1-101	6-555
USMPS (5)	1-107	6-556
USATSCH (5)	1-207	6-557
Frankford Arsenal (5)	1-257	6-558
Edgewood Arsenal (5)	1-258	6-575
Redstone Arsenal (5)	1-307	6-576
USATC Armor (2)	3-267	6-577
USATC Engr (2)	5-7	6-585
USATC Inf (2)	5-25	6-615
USASTC (2)	5-26	6-617
WRAMC (1)	5-27	6-700
Army Pic Cen (2)	5-35	6-701
USACDCEC (10)	5-37	6-705
USAOEC (5)	5-116	6-706
USATTC (5)	5-129	6-707
Instl (2) except	5-145	6-715
Ft Hancock (4)	5-146	6-716
Ft Carson (25)	5-147	6-725
Ft Gordon (10)	5-148	6-726
Ft Huachuca (10]	5-155	7
WSMR (5)	5-156	7-4
Ft Knox (12)	5-215	7-15
DPG (5)	5-217	7-16
Ft Lee (5)	5-500 (AA-A D, MC)	7-17
Ft Devens (5)	6-37	7-18
Ft Belvoir (5)	6-100	7-35
APG (5)	6-101	7-36
USAEPG (5)	6-155	7-37
Army Dep (2) except	6-156	7-42
LBAD (14)	6-165	7-46
SAAD (30)	6-166	7-46
TOAD (14)	6-175	7-47
LEAD (7)	6-176	7-56
SHAD (3)	6-177	7-56
N <sup>A</sup> AD (5)	6-200	7-57
SVAD (5)	6-201	7-58
CHAD (3)	6-215	7-100
ATAD (10)	6-216	8-26
TEAD (5)	6-300	8-26
GENDEPS (2)	6-302	8-27
Sig Sec GENDEPS (5)	6-436	9-7
Sig Dep (12)	6-315	9-17
USABIOLABS (5)	6-316	9-22
Sig FLDMS (2)	6-317	9-47
AMC (1)	G-319	9-127
USAERDAA (2)	6-355	9-377
USAERDAW (13)	6-356	9-510
USACRREL (2)	6-365	11-35
MAAG Vietnam (5)	6-366	11-37
KMAG (5)	6-401	11-38
USASETAF (5)	6-405	11-39
USARSG (5)	6-415	11-67
Units org under fol TOE:	6-416	11-96
(2 cys each)	6-417	11-97
1-7	6-419	11-98
1-37	6-425	11-99
1-47	6-429	11-117
1-56		11-127

## FIXED OPERATION WITH LONG RANGE ANTENNAS

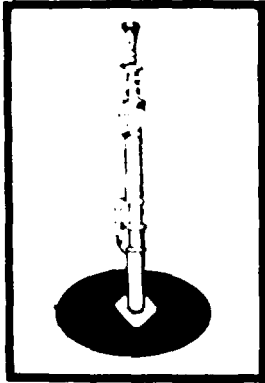
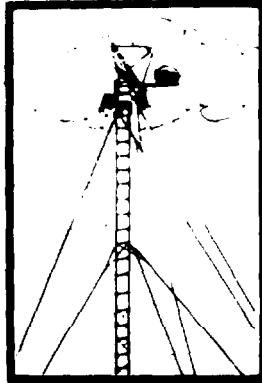
**W A R N I N G**TELESCOPING  
ANTENNA MAST

TYPICAL TOWER

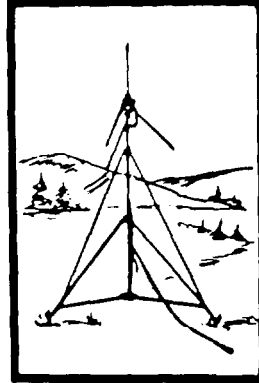
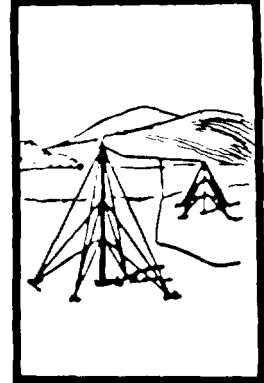
EXTENDED RANGE DOUBLET ANTENNA  
ANTENNA**NEVER ERECT THESE LONG RANGE ANTENNAS DIRECTLY UNDER POWERLINES.**

IF YOU MUST ERECT THESE LONG RANGE ANTENNAS NEAR POWERLINES, POWERLINE POLES OR TOWERS, OR BUILDINGS WITH OVERHEAD POWERLINE CONNECTIONS, NEVER PUT THE ANTENNA CLOSER THAN TWO TIMES THE ANTENNA HEIGHT FROM THE BASE OF THE POWERLINE, POLE, TOWER OR BUILDINGS,

**NEVER ATTEMPT TO ERECT ANY LONG RANGE ANTENNA WITHOUT A FULL TEAM.**

BEFORE ERECTING ANY LONG RANGE ANTENNA, INSPECT ALL THE PARTS MAKING UP THE ANTENNA KIT. DO NOT ERECT THE ANTENNA IF ANY PARTS ARE MISSING OR DAMAGED.

DO AS MUCH OF THE ASSEMBLY WORK AS POSSIBLE ON THE GROUND.

WHEN ERECTING THE ANTENNA, ALLOW ONLY TEAM PERSONNEL IN THE ERECTION AREA.

MAKE SURE THAT THE AREA FOR THE ANCHORS IS FIRM. IF THE GROUND IS MARSHY OR SANDY, GET SPECIFIC INSTRUCTIONS FROM YOUR CREW CHIEF OR SUPERVISOR ON HOW TO REINFORCE THE ANCHORS.

WHEN SELECTING LOCATIONS FOR ANCHORS, AVOID TRAVELED AREAS AND ROADS. IF YOU CANNOT AVOID THESE AREAS, GET SPECIFIC INSTRUCTIONS FROM YOUR SUPERVISOR AS TO WHAT CLEARANCE YOUR GUY WIRES AND ROPES MUST HAVE OVER THE TRAVELED AREAS AND ROAD.

CLEARLY MARK ALL GUY WIRES AND ROPES WITH THE WARNING FLAGS OR SIGNS SUPPLIED BY YOUR UNIT. IN AN EMERGENCY, USE STRIPS OF WHITE CLOTH AS WARNING STREAMERS.

IF YOU SUSPECT THAT POWERLINES HAVE MADE ACCIDENTAL CONTACT WITH YOUR ANTENNA, STOP OPERATING, ROPE OFF THE ANTENNA AREA. AND NOTIFY YOUR SUPERIORS.

IF THE WEATHER IN YOUR AREA CAN CAUSE ICE TO FORM ON YOUR LONG RANGE ANTENNA AND ITS GUY WIRES AND ROPES, ADD EXTRA GUYS TO SUPPORT THE SYSTEM. ROPE OFF THE AREA AND POST IT WITH WARNING SIGNS LIKE " BEWARE OF FALLING ICE."

DO NOT TRY TO ERECT ANY ANTENNA DURING AN ELECTRICAL STORM.

KEEP A SHARP EYE ON YOUR ANCHORS AND GUYS. CHECK THEM DAILY AND IMMEDIATELY BEFORE AND AFTER BAD WEATHER.

WARNING

Remove the battery from Battery Box CX-2562/PRC when RT-505/PRC is not being used. This is required to ensure that hydrogen (a by-product of Magnesium Battery BA-4386/U discharge action) does not accumulate. Personnel can be injured and equipment damaged if the gas explodes.

WARNING

Prevent personnel injury when applying or removing steel strapping, by wearing heavy gloves and a face shield. Do not handle packing cartons by the steel strapping.

WARNING

Fumes of TRICHLOROTRIFLUOROETHANE are poisonous. Provide adequate ventilation whenever you use TRICHLOROTRIFLUOROETHANE. Do not use solvent near heat or open flame. TRICHLOROTRIFLUOROETHANE will not burn, but heat changes the gas into poisonous, irritating fumes. DO NOT breathe the fumes or vapors. TRICHLOROTRIFLUOROETHANE dissolves natural skin oils. DO NOT get the solvent on your skin. Use gloves, sleeves and an apron which the solvent cannot penetrate. If the solvent is taken internally, consult a physician immediately.



**OPERATOR'S AND ORGANIZATIONAL MAINTENANCE MANUAL  
 INCLUDING REPAIR PARTS AND SPECIAL TOOLS LISTS**

**RADIO SET AN/PRC-25 (NSN 5820-00-857-0759)  
 (INCLUDING RECEIVER-TRANSMITTER, RADIO RT-505/PRC-25  
 (5820-00-857-0934))**

	<i>Paragraph</i>	<i>Page</i>
<b>CHAPTER 1. INTRODUCTION</b>		
Section I. General		
Scope-----	1-1	1-1
Indexes of publications-----	1-2	1-1
Forms and records-----	1-3	1-1
Reporting equipment improvement recommendations-----	1-3.1	1-1
Reporting of errors-----	1-3.2	1-1
Administrative storage-----	1-3.3	1-1
Destruction of Army electronics materiel-----	1-3.4	1-2
11. Description and Data		
Purpose and use-----	1-4	1-2
Technical characteristics-----	1-5	1-2
Items comprising an operable equipment-----	1-6	1-2.1
General description-----	1-7	1-2.1
Receiver-Transmitter, Radio RT-505/PRC-25-----	1-8	1-2.1
Minor components-----	1-9	1-2.1
Additional equipment required-----	1-10	1-3
<b>CHAPTER 2. INSTALLATION</b>		
Unpacking-----	2-1	2-1
Checking unpacked equipment-----	2-2	2-1
Siting-----	2-3	2-1
Installation of battery-----	2-4	2-2
Assembly and installation for man-pack operation-----	2-5	2-3
Installation of antenna-----	2-6	2-5
3. OPERATING INSTRUCTIONS		
Receiver-Transmitter Radio RT-505/PRC-25, controls, indicators, and connectors-----	3-1	3-1
Presetting channel frequencies-----	3-2	3-2
Selecting preset channels-----	3-3	3-3
Operating procedure-----	3-4	3-3
Stopping procedure-----	3-5	3-5
Recognition and identification of jamming-----	3-6	3-5
Antijamming-----	3-7	3-5
Operating procedures under arctic conditions-----	3-8	3-5
Homing operation-----	3-9	3-5
Conditions for squelch and nonsquelch operation-----	3-10	3-6
System application-----	3-11	3-6
<b>CHAPTER 4. OPERATOR'S MAINTENANCE INSTRUCTIONS</b>		
Section I. Preventive Maintenance		
Scope of operator's maintenance-----	4-1	4-1
Preventive maintenance, general-----	4-2	4-1
Cleaning-----	4-4	4-5

1 This manual supercedes TM 11-5820-398-10, 29 October 1962, including C 4, 30 July 1965; TM 11-5820-98-20, 3 December 1962, including C 1, 11 April 1963; TM 11-5820-398-20P, 17 November 1964; and TM 11-5820-497-20P, 21 April 1964.

	<i>Paragraph</i>	<i>Page</i>
II. Troubleshooting		
Visual inspection-----	4-4	4-5
Troubleshooting -----	4-6	4-5
CHAPTER 5. ORGANIZATIONAL MAINTENANCE		
Section 1. General		
Scope of organizational maintenance -----	5-1	5-1
Tools, materials, and test equipment required -----	5-2	5-1
II. Preventive Maintenance		
Organizational preventive maintenance checks and services (PMCS) -----	5-3	5-1
111. Troubleshooting		
Visual inspection -----	5-4	5-3
Equipment performance checklist -----	5-5	5-3
Repair and replacement parts -----	5-6	5-3
Use of Test Sets, Radio Frequency AN/USM-182 and TS-2600/U -----	5-7	5-5
CHAPTER 6. MATERIEL USED IN CONJUNCTION WITH RADIO SET AN/PRC-25		
Radio relay procedures and Retransmission Cable Kit MK-456(•)/GRC -----	6-1	6-1
Battery, Dry BA-398/U for Arctic operation -----	6-2	6-4
Antenna Equipment RC-292 -----	6-3	6-4
Antenna, Homing Loop AT-784/PRC -----	6-4	6-4
Antenna AT-984A/G, installation and maintenance -----	6-5	6-6
Loudspeaker, Electromagnetic LS-549/PRC (deleted) -----	6-6	6-9
Radio Set Control Group AN/GRA-39(•) -----	6-7	6-9
Radio Set Control AN/GSA-7 and Oscillator, Audio Frequency O-574/GRA-----	6-8	6-12
Control Group AN/GRA-6-----	6-9	6-21
7. SHIPMENT AND LIMITED STORAGE		
Disassembly of equipment -----	7-1	7-1
Repackaging for shipment or limited storage -----	7-2	7-1
APPENDIX A. REFERENCES -----		A-1
B. COMPONENTS OF END ITEM LIST		
Section I. Introduction -----		B-1
II. Integral Components of End Item -----		B-2
APPENDIX III. MAINTENANCE ALLOCATION		
Section 1. Introduction -----		AIII-1
II. Maintenance Allocation Chart -----		AIII-3
APPENDIX IV. ORGANIZATIONAL MAINTENANCE REPAIR PARTS AND SPECIAL TOOLS LIST		
section I. Introduction -----		AIV-1
II. None		
III. None		
IV. None		
V. None		
VI. None		
VIII. Repair Parts for Organizational Maintenance (RT-505/PRC-25) -----		AIV-7
IX. None		
X. Index—Federal Stock Number Cross-Reference to Figure and Item Number or Reference Designation -----		AIV-8
XI. Index—Reference Designation Cross-Reference to Page Number (RT-505/PRC-25) -----		AIV-9
APPENDIX E. ADDITIONAL AUTHORIZATION LIST		
Section 1. Introduction -----		E-1
II. Additional Authorization List -----		E-2
APPENDIX F. EXPENDABLE SUPPLIES AND MATERIALS LIST		
Section 1. Introduction -----		F-1
II. Expendable Supplies and Materials List -----		F-2





TM 5820-398-10-1

*Figure 1-1. Radio Set AN/PRC-25 in operation.*

## CHAPTER 1

### INTRODUCTION

---

#### Section I. GENERAL

##### 1-1 Scope

a. This manual describes Radio Set AN/PRC-25 and covers its installation, operation, and operator's and organizational maintenance. It includes instructions for cleaning, checking, and inspecting the equipment.

b. The basic issue items list, maintenance allocation chart, and the organizational repair parts and special tool lists are also included in this manual. An items troop installed or authorized list is not applicable to this equipment.

##### 1-2 Consolidated index of Army Publications and Blank Forms

Refer to the latest issue of DA Pam 25-30 to determine whether there are new editions, changes, or additional publications pertaining to the equipment.

##### 1-3 Maintenance Forms, Records, and Reports

a. Reports of Maintenance and Unsatisfactory Equipment. Department of the Army forms and procedures used for equipment maintenance will be those prescribed by DA Pam 738-750, as contained in Maintenance Management Update.

b. Report of Packaging and Handling Deficiencies. Fill out and forward SF 364 (Report of Discrepancy (ROD)) as prescribed in AR 735-11-2/DLAR 4140.55/NAVMATINST 4355.73B/AFR 400-54/MCO 4430.3H.

c. Discrepancy in Shipment Report (DISREP) (SF 361). Fill out and forward Discrepancy in Shipment Report (DISREP) (SF 361) as prescribed in AR 55-38/NAVSU-PINST 4610.33C/AFR 75-18/MCO P4610.19D/DLAR 500.15.

##### 1-3.1 Reporting Equipment improvement Recommendations (EIR)

a. Army. If your equipment needs improvement, let us know. Send us an EIR. You, the user, are the only one who can tell us what you don't like about the design. Put it on an SF 368 (Quality Deficiency Report). Mail it to Commander, US Army Communications-Electronics Command and Fort Monmouth, ATTN: AMSEL-PA-MA-D, Fort Monmouth, New Jersey 07703-5000. We'll send you a reply.

##### 1-3.2 Reporting Errors and Recommending Improvements

You can help us improve this manual. If you find any mistakes or if you know of a way to improve the procedures, please let us know. Mail your letter or DA Form 2028 (Recommended Changes to Publications and Blank Forms) direct to: Commander, US Army Communications-Electronics Command and Fort Monmouth, ATTN: AMSEL-ME-MP, Fort Monmouth, New Jersey 07703-5000.

##### 1-3.3 Administrative Storage

Administrative storage of the AN/PRC-25 will be handled as follows:

- a. Remove the battery; clean the battery compartment.
- b. Before and after storage, perform the following:
  - (1) Inventory the equipment (app II).
  - (2) Clean the equipment (para 4-6).
  - (3) Check the operation of the equipment (para 5-7),
- c. During storage, inventory the equipment and perform an operational test of sidetone.

These checks may be done approximately every 3 or 4 months.

d. Store the equipment in a dry and moisture-free area with safeguards against pilfering.

**Section II. DESCRIPTION AND DATA**

**1-4. Purpose and Use**

(fig. 1-1)

u. Radio Set AN/PRC-25 is a short-range, manpack portable, frequency modulated (FM) receiver-transmitter used to provide two-way voice communication.

b. Receiver-Transmitters, Radio RT-505/PRC-25 and RT-505A/PRC25, part of the AN/PRC-25, are also used as part of vehicular Radio Sets AN/VRC-53 and AN/GRC-125 (TM 11-5820498-12).

c. FM radio sets with which the AN/PRC25 can communicate are listed in paragraph 3-11 (fig. 3-3).

d. The AN/PRC-25 can also be used in conjunction with other equipment ((1) through (6) below).

(1) The AN/PRC-25 can be connected to other FM radio sets for radio relay use by means of Retransmission Cable Kit MK-456(\*)/GRC (para 6-1) (TM 11-5995-202-15). Typical FM radios include:

(a) AN/PRC-25 and AN/PRC-77 (TM 11-5820-667-12).

(b) Vehicular versions and manpack radios: AN/VRC-53, AN/VRC-64, AN/GRG-125, and AN/GRC-160 (TM 11-5820498-12).

(c) AN/VRC-12 series radios (TM 11-5820-101-12).

(2) Remote control of the AN/PRC-25 can be provided by Radio Set Control Group AN/GRA-39(\*) (para 6-7) and Radio Set Control AN/GRA-6 (para 6-9a).

(3) Radio wire integration (RWI) operation with the AN/PRC-25 and remote telephone facilities can be provided by Radio Set Control AN/GSA-7 with Oscillator O-574/GRC (para 6-8). Also, the AN/GRA-39(\*) and AN/GRA-6 can be used with the AN/PRC-25 for RWI (para 6-7b and 6-9b).

(4) The AN/PRC-25 can be used with Antenna, Homing Loop AT-784/PRC (para 6-4) for

**1-3.4. Destruction of Army Electronics Materiel**

Destruction of Army electronics materiel to prevent enemy use shall be in accordance with TM 750-244-2.

detection and location of homing beacons or other FM radios.

(5) The AN/PRC-25 can be used with Antenna AT-984A/G (para 6-5), a long-wire, multiple-wavelength antenna, to extend the transmission and reception ranges.

(6) Antenna Equipment RC-292 (TM 11-5820-348-15) and Antenna Group OE-254/GRC (TM 11-5985-357-13) can be used in place of the whip antennas to extend the communication distance (para 6-3).

**1-5. Technical Characteristics**

Frequency range	
Low band -----	30.00 to 52.95 mc.
High band -----	53.00 to 75.95 mc.
Number of channels -----	920.
Channel spacing -----	50 kc.
Types of transmission and reception:	
Transmission -----	Voice and 150-cps squelch tone.
Reception -----	Voice (no squelch); or voice and 150-cps squelch tone.
Transmission and reception power requirements:	
Transmission -----	2.5 to 3 vdc, 0.4 amp; 12.5 to 15 vdc, 1.4 amp.
Reception -----	12 to 15 vdc, 0.6 amp.
Type of modulation -----	Frequency.
Transmitter output power	1.1 to 2-0 watts.
Type of squelch -----	Tone operated by 150-cps signal.
Distance range -----	5 miles (8 kilometers varies with conditions).
Types of antennas:	
Short antenna -----	Antenna AT-892/PRC-25; 3 feet long, semirigid steel tape.
Long antenna -----	Antenna AT_271/PRC; 10 feet long, multisection whip.
Power source -----	Batteries, Dry BA-4386/U, BA-398/U (para 1-10).
Battery life -----	60 hours (with a 9-to-1 receiver-transmit ratio).

**1-2 Change 6**

## 1-6. Items Comprising an Operable Equipment

Refer to appendix B for items comprising the AN/PRC-25. See paragraph 1-10 for information on the batteries required for the AN/PRC-25.

### 1-7. General Description

(fig. 1-2)

a. Radio Set AN/PRC-25 consists of Receiver-Transmitter, Radio RT-505/PRC-25 and minor components. Bag, Cotton Duck CW-503/PRC-25 is used to store the antennas and handset (para 1-8f). Harness, Electrical Equipment ST-138/PRC-25 is used to carry the RT-505/PRC-25.

b. Receiver-Transmitters, Radio RT-505/PRC-25 and RT-505A/PRC are similar components. The module cases in both models are identical; however, the module internal circuits of the RT-505A/PRC25 are micromodularized. The modules are physically and electrically interchangeable between the two radios. Reference to RT-505/PRC in this manual also applies to RT-505A/PRC-25.

### 1-8. Receiver-Transmitter, Radio RT-505/PRC-25

(fig. 1-2)

The RT-505/PR-25 consists of the receiver-transmitter, the receiver-transmitter case, and Battery Box CY-2562/PRC-25.

a. The receiver-transmitter is held in the receiver transmitter case by four captive screws (fig. 2-2). The CY-2562/PRC-25 is attached to the receiver-transmitter case by two clamps. The complete RT-505/PRC-25, when assembled, is watertight. All controls are located on the front panel. A battery plug projects *from* the receiver-transmitter and mates with the connector of the battery.

b. The CY-256/PRC-25 is a lightweight metal case that protects and houses the battery. The battery sits on a foam rubber pad which is attached to the bottom of the CY-2562/PRC-25.

c. A pressure relief valve (fig. 2-2) is installed in CY-2562/PRC-25 to prevent hydrogen gas (a byproduct of magnesium Battery, Dry BA-4386/U discharge action) from accumulating in the RT-505/PRC-25 case and possibly exploding. The valve is provided in accordance with

MWO 11-5800-211-1, 13 September 1972, to prevent injury to personnel and prevent serious damage to the RT-505/PRC-25. If the valve is not installed, it must be installed by higher maintenance facilities.

### 1-9. Minor Components

(fig. 1-2)

a. *Antenna AT-892/PRC-25.* The AT-892/PRC-25 is a two-section, 3-foot-long whip antenna. A spring at its base allows for positioning the antenna to keep it in a vertical position, regardless of the position of the RT-505/PRC 25. This antenna is used for general short-range service and, because of its steel tape construction, can be folded into a small space.

b. *Antenna AT-271-A/PRC.* The AT-271A/PRC is composed of 7 sections; each section fits into the end of a wider section. A stainless-steel plastic-covered cable (or braided plastic cord), under spring tension, is threaded through the sections to keep them together in operating condition. When the sections are folded, the cable keeps them to-





gether as a group, to prevent the loss of individual sections. Spring tension is provided by a spiral spring in the base section. This antenna is used when maximum range is required.

c. Support, *Antenna AB-591/PRC-25*. The AB-591/PRC-25, which is of rigid tubular construction, is used as a main support of the AT-271A/PRC.

d. Harness, *Electrical Equipment ST-138/PRC-25*. The ST-138/PRC-25 is made of cotton duck. It is used to secure the RT-505/PRC-25 so that it can be carried on the operator's back.

e. Bag, *Cotton Duck CW-503/PRC-25*. The CW-503/PRC-25 is sectionalized into several pockets which are used to store the two antennas and the handset.

f. *Handset*. Handset H-138 (\*)/U (fig. 1-2) (H-138(\*)/U represents the H-138/U and H-138A/U) or Handset H-189/GR (fig. 1-3) (handset) may be used with the AN/PRC-25 (radio set). Maintenance instructions and repair parts lists for the H-138(\*)/U are given in TM 11-596, 257-15 and for the H-189/GR, in TM 11-5965-280-15. The handset consists of a microphone and a receiver section.

The retractable cord is terminated in a five-pin connector. A push-to-talk switch is mounted in the handle. The H-138(\*)/U microphone has two elements, each under a separate opening, for cancellation of outside noise.

#### 1-10. Additional Equipment Required (fig. 2-2)

a. Battery, Dry BA-386 PRC-25 or BA-4386/U is not supplied as part of the AN/PRC-25 but is required for its use. The battery is supported and housed in the CY-2562/PRC-25. Either battery supplies 3 and 15 volts and is provided with a female connector to mate with the RT-505/PRC-25 battery plug.

Note. All references in this manual to BA-386/PRC-25 applies also to the BA-4386/U.

##### b. *The* BA-386/PRC-25

is a standard carbon dry cell battery; the BA-4386/U is a *magnesium* cell battery that will operate the radio approximately twice as long as the BA-386/PRC-25.

c. For arctic operation, Battery, Dry BA-898/U may be used. See paragraph 6-2 for details.

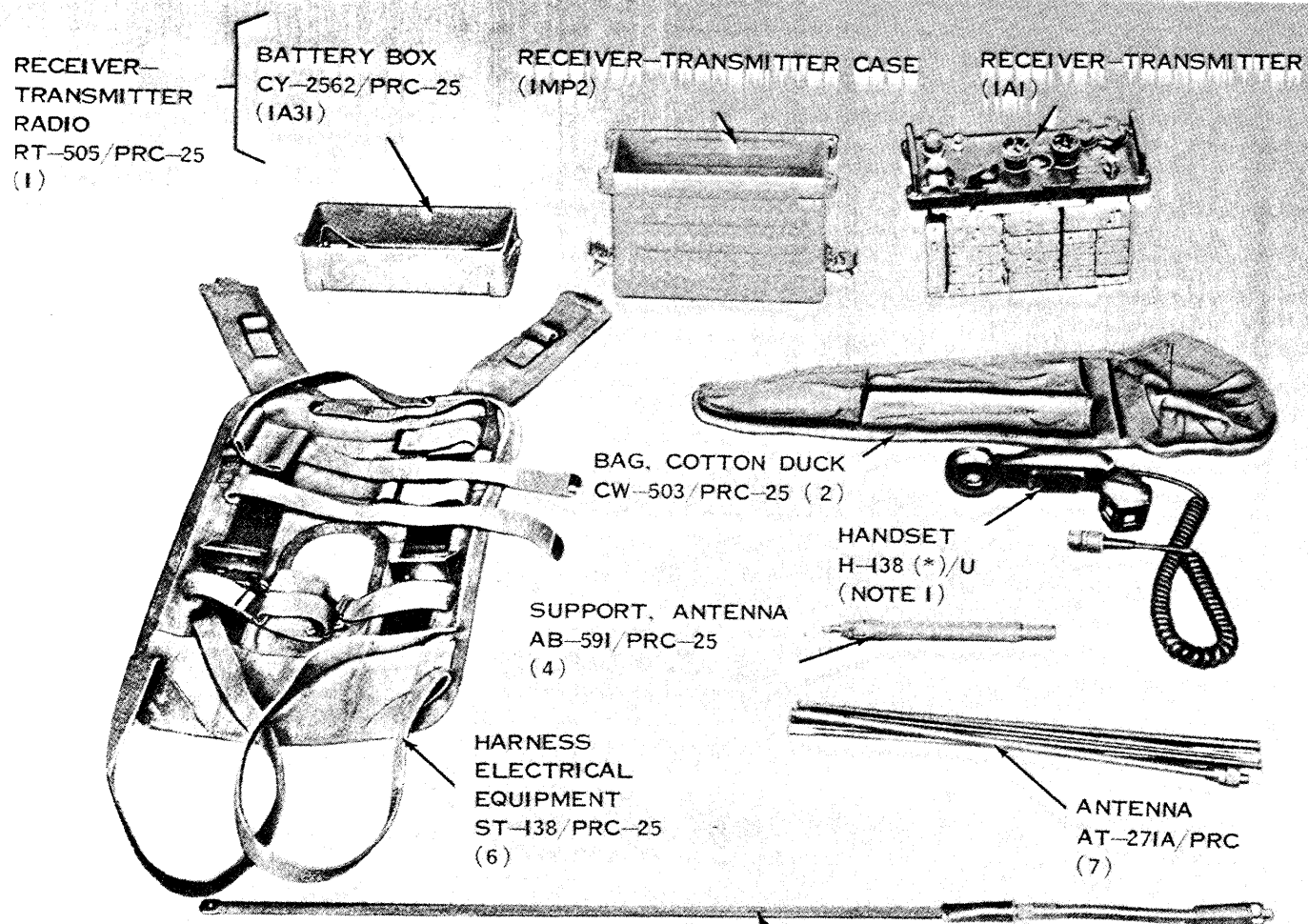

EL 5820-398-12-C3-TM-1

Figure 1-2. Radio Set AN/PRC-25, components.

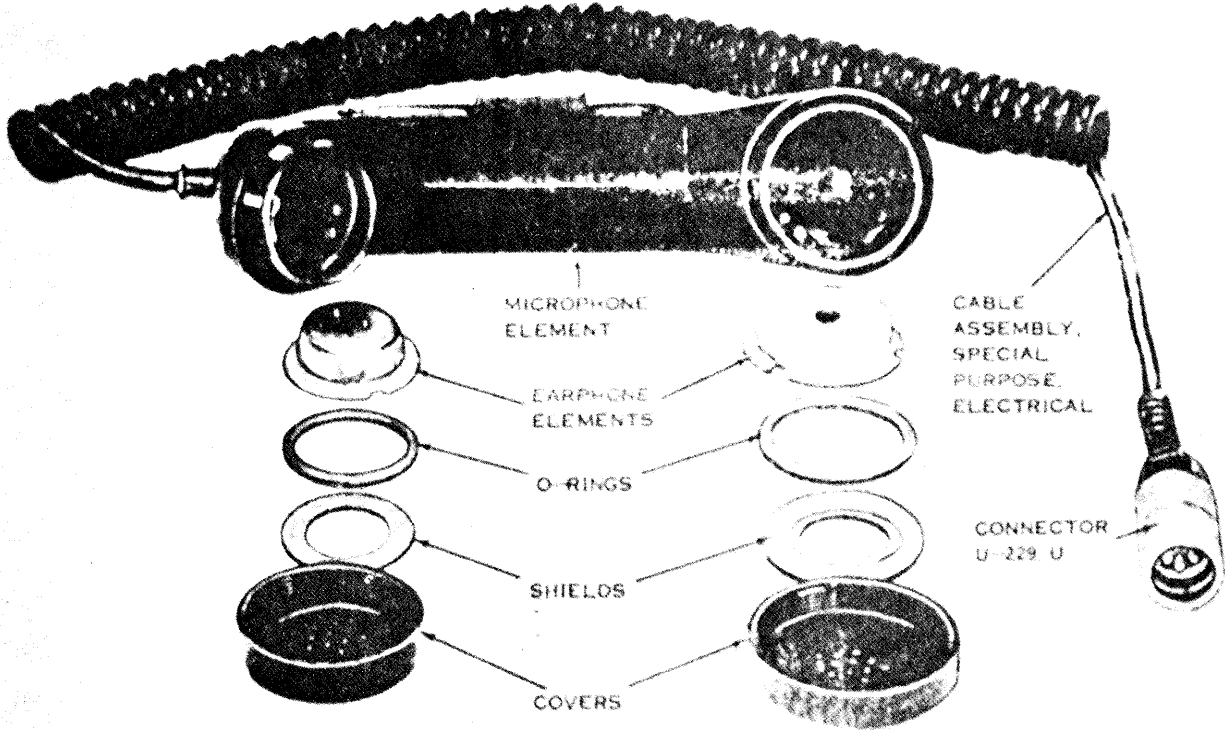

TM5820-398-12-C2-7

Figure 1-3. Handout Handset H-189/GR, disassembled.



**CHAPTER 2**  
**INSTALLATION**

**2-1. Unpacking**

(fig. 2-1)

a. *Packaging Data.* When pricked for shipment, the components of the AN/PRC-25 are placed in an inner carton. A moisture-vapor-proof barrier is placed around the inner carton. This package is placed in an outer carton. The outer carton is covered with a second moisture-vaporproof barrier and placed in a wooden packing box. The dimensions of the wooden packing box are 17 inches deep, 13 inches wide, and 9¾ inches high. The weight of the pricked equipment is 20 pounds.

**b. Component Dimensions.**

Component	Overall dimensions (in.)			Volume (cu in.)	Weight (lb)
	Height	Width	Depth		
Receiver-Transmitter, Radio RT-505/PRC-25	4	11	11	484	13.5
Battery Box CY-2562/PRC-25	4	3	11	132	0.75
Support, Antenna AB-591/PRC-25	9	0.75	0.75	50	0.75
Antenna AT-892/PRC-25 (folded)	18.5	1	1.5	28	0.5
Antenna AT-271A/PRC (folded)	17	0.75	.75	9	0.75
Harness, Electrical Equipment ST-138/PRC-25	19	6	5	520	3
Bag, Cotton Duck CW-503/PRC-25	19	4	6	456	0.75
Handset H-189/GR	8.5	3	2.5	63.75	1.5

**c. Removing Contents.**

**WARNING**

Prevent personal injury when applying or removing steel strapping. Wear heavy gloves and a face shield. Do not handle packing cartons by the steel strapping.

Note. When unpacking equipment that is packed only in cartons, omit the procedure given in (1), (2), and (8) below.

- (1) Cut and fold brick the metal straps.
- (2) Remove the nails from the top and one side of the wooden packing box with a nailpuller. Do not pry off the boards  
  
Prying may damage the equipment.
- (3) Open the moisture-vaporproof barrier that covers the outer carton.
- (4) Open the outer carton, open the second moisture-vaporproof barrier that covers the inner carton.
- (5) Remove and open the inner carton.
- (6) Remove the corrugated filler.
- (7) Remove and open the envelope that contains the technical manuals.
- (8) Remove the major and minor components.

**2-2. Checking Unpacked Equipment**

a. Inspect the equipment for possible damage incurred during shipment. If the equipment has been damaged, report the damage on SF 364.

b. See that the equipment is complete as listed on the packing slip. If the packing slip is not available, check the equipment against the basic issue items list (app. II). Report all discrepancies in accordance with DA-Pam 738-750. Shortage of a minor assembly or part that does not affect proper functioning of the equipment should not prevent use of the equipment.

c. If the equipment has been used or reconditioned, see whether it has been changed by a modification work order (MWO). If the equipment has been modified, the MWO number will appear on the front panel, near the nomenclature plate. Check to see whether the MWO number (if any) and appropriate notations concerning the modification have been entered in the equipment manual.

**NOTE**

Current MWO'S applicable to the equipment are listed in DA Pam 25-30.

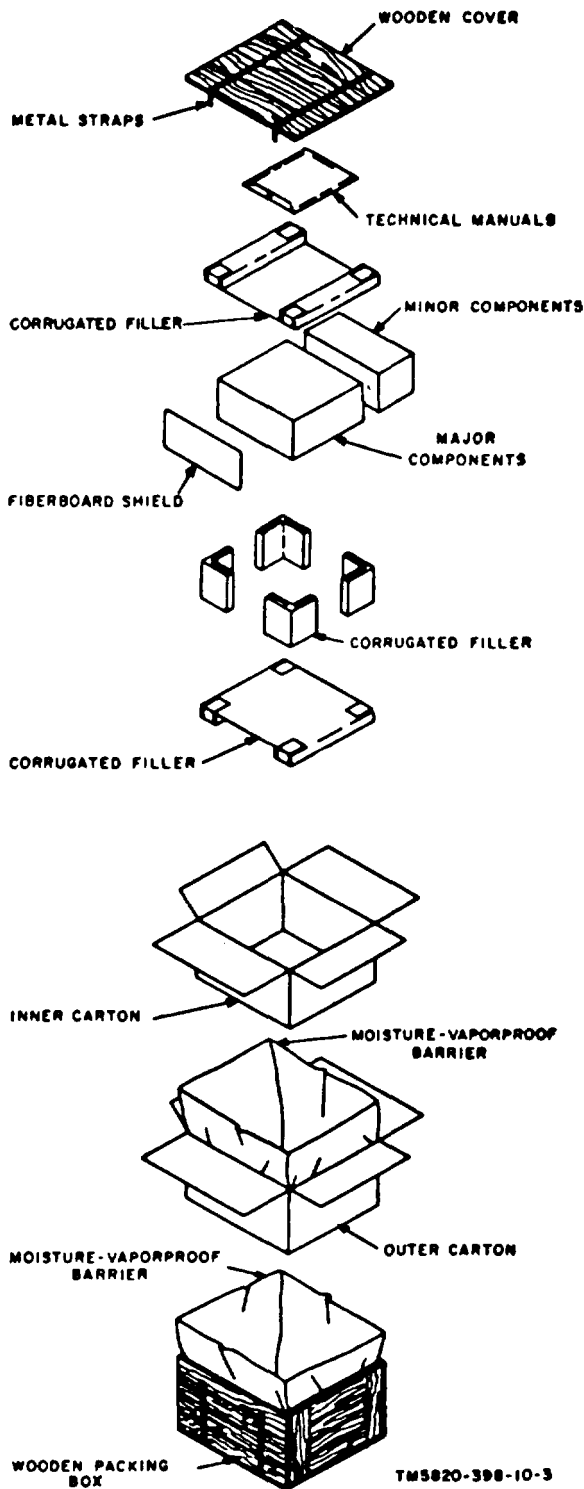

Figure 2-1. Typical packing.

### 2-3. Siting

The AN/PRC-25 operates at low power and on high frequencies; therefore, the location of the equipment greatly affects its operating range. Normally, a line-of-sight range can be expected; that is, if the other station can be seen, satisfactory operation is probable. An intervening hill or tall building may hamper or prevent contact with the other stations. Valleys, densely wooded areas, and low places are poor sites. Location on a hilltop or a tower will increase operating distances. If possible, avoid locations near a source of electrical interference, such as powerlines, telephone lines, radar sets, and field hospitals.

### 2-4. Installation of Battery

(fig. 2-2)

Test Set, Battery AN/PSM-13 (TM 11-6625-823-15) may be used to check Battery, Dry BA-4386/U.

- a. Stand the RT-505/PRC-25 on a level surface with its front panel facing downward.
- b. Release the two clamps by pushing the topmost part of each clamp down and away from the case.
- c. Remove the CY-2562/PRC-25.
- d. Inspect the radio connector; if it is damaged or loose, the RT-505/PRC-25 must be repaired. Tighten the pressure test screw if it is not sealed with epoxy. Tighten the pressure relief valve.
- e. Position the new battery connector in line with the radio connector until the two connectors are mated.
- f. Install the CY-2562/PRC-25 on the RT-505/PRC-25 case and tighten the two clamps.
- g. To remove the battery, perform procedures in a, b, and c above.

#### NOTES

Remove the battery when the equipment is not in use for more than a day.

Magnesium Battery, Dry BA-4386/U does not require refrigeration before initial use to retain its power. But, when it has been in use over approximately 5 hours (approximately 10 percent of its power used), store the battery in a cool and moisture-free area. This procedure will prolong its useful life.

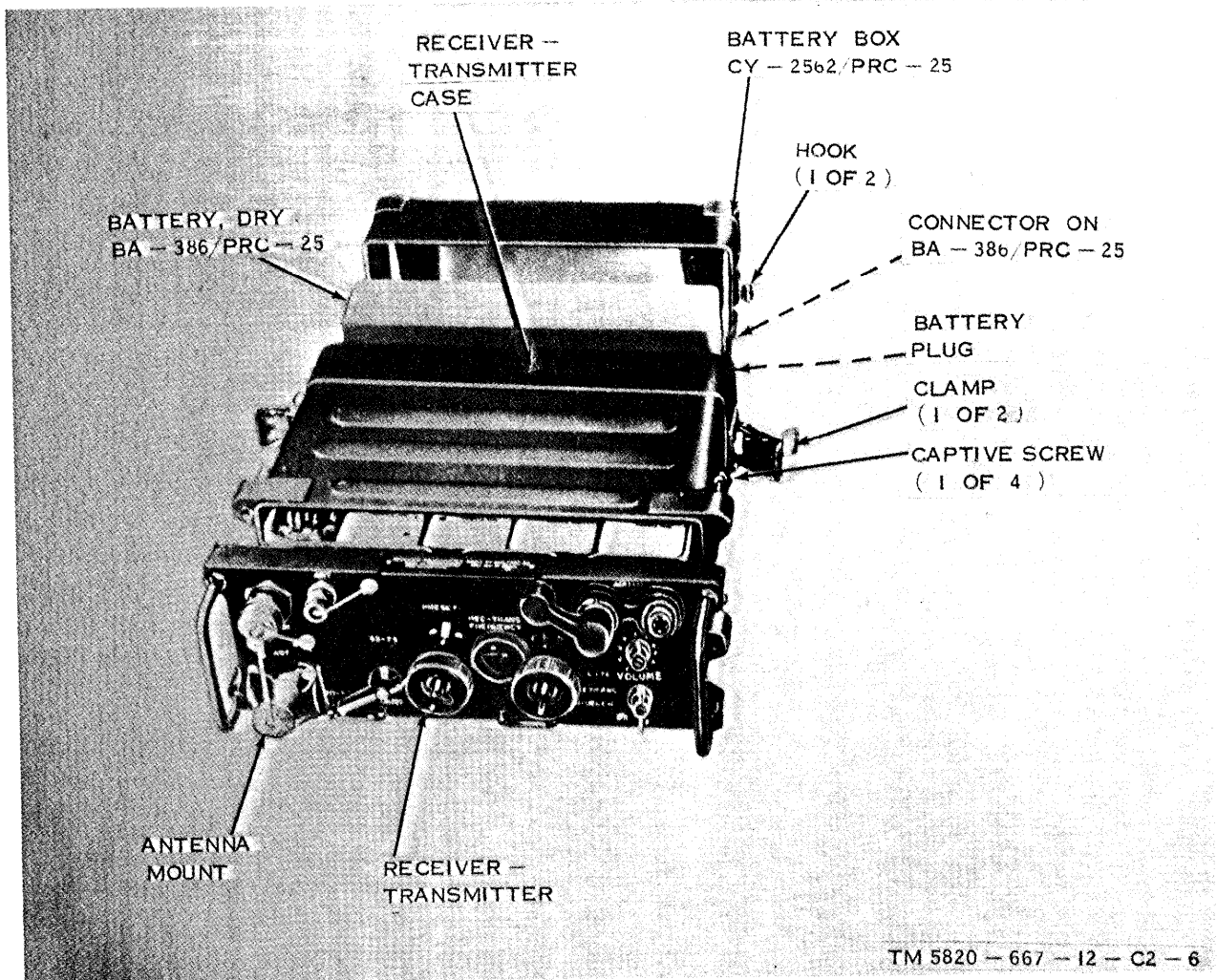

TM 5820 - 667 - 12 - C2 - 6

Figure 2-2. Installation of battery in RT-505/PRC-25.

### CAUTIONS

Observe the following procedures to dispose of a worn-out battery:

Do not compact or incinerate the battery.

Do not dispose of the battery in streams, rivers, and oceans, etc. Shipboard users will retain the battery for shore disposal.

Dispose of the battery in a sanitary landfill.

### 2-5. Assembly and Installation for Manpack Operation

a. Attach the ST-138/PRC-25 (fig. 2-3) to the RT-505/PRC-25 as instructed in (1) through (4) below.

#### NOTE

install the battery in the RT-505/PRC-25 before proceeding (para 2-4, fig. 2-2).

(1) Place the ST-138/PRC-25 flat on a level surface with the metal braces facing up.

(2) Place the RT-505/PRC-25 on the ST-138/PRC-25 with its front panel toward the top and the CY-2562/PRC-25 resting on the metal braces of the ST-138/PRC-25.

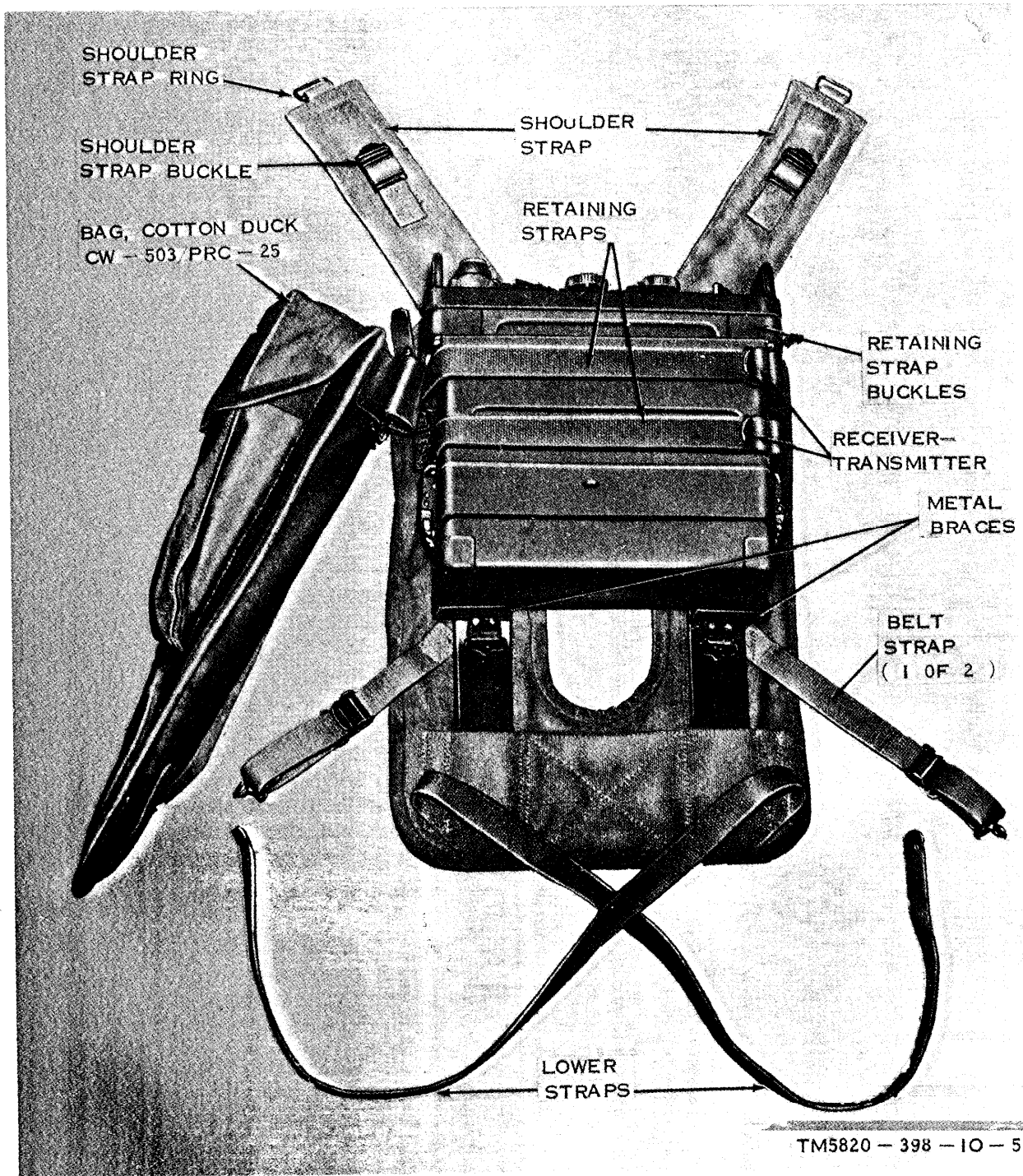

Figure 2-3. Installation of receiver-transmitter in ST-138/PRC-25.



(3) Fasten the RT-505/PRC-25 to the ST-138/PRC-25 with the two retaining straps; feed the metal-tipped strap from below, through the center slot on the buckle and then down through the end slot in the buckle.

(4) Clip the CW-503/PRC-25 to the ST-138/PRC-25.

b. Mount the ST-138/PRC-25 (fig. 2-4) on the operator as follows:

(1) Install the desired antenna (para 2-6).

(2) Connect the handset to one of the AUDIO connectors on the front panel of the RT-505/PRC-25.

(3) Place the ST-138/PRC-25, with the RT-505/PRC-25 attached, on the operator's back. Place the shoulder straps over the operator's shoulders.

(4) Feed the end of the right lower strap through the right shoulder strap ring. Feed the metal tip of the strap from below, through the center slot in the buckle and then down through the end slot (fig. 2-3).

(5) Feed the end of the left lower strap through the ring of the left shoulder strap. Feed the metal tip of the strap from below, through the center slot in the buckle and then down through the end slot in the buckle (fig. 2-3).

(6) Hook the two belt straps to the combat belt.

## 2-6. Installation of Antennas

Use the AT-892/PRC-25 (short antenna) when maximum range is not required, Use the AT-271A/PRC (long antenna) when maximum range is required.

a. *Antenna AT-892/PRC-25.* See *d* below.

(1) Remove the cover from the ANT mount (fig. 3-1).

(2) Screw the bottom of the AT-892/PRC-25 into the ANT mount. Make sure AT-892/PRC-25 is tightened down fully; check its tightness often. See caution in *d* below.

b. *Antenna AT-271A/PRC.*

(1) Remove the cover from the ANT mount (fig. 3-1).

(2) Screw Support, Antenna AB-591/PRC-25 into the ANT mount.

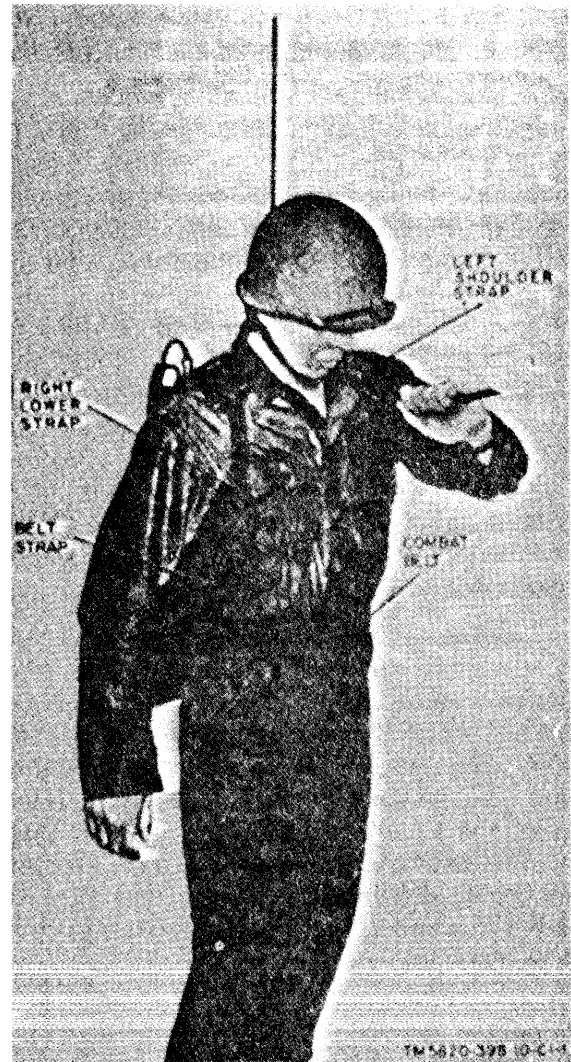

Figure 2-4. Installation AN/PRC-25 for man-pack operation.

(3) Extend the AT-271A/PRC by holding the base section (the heaviest section) and carefully whipping it outward. If all sections are not secure, repeat the procedure or insert the sections individually by hand.

(4) Secure the extended AT-271A/PRC into the AB-591/PRC-25. Make sure AT-271A/PRC is tightened down fully; check its tightness often. See caution in *d* below.

c. *Other antennas.* To use other antennas, refer to paragraph 6-3 for ground-plane Antenna Equipment RC-292 (for long-distance

operation), paragraph 6-4 for Antenna, Homing Loop AT-784/PRC (to detect other radio stations), and paragraph 8-6 for Antenna AT-984A/G (a long-wire antenna).

d. *Orientation of AT-892/PRC-25.* The AT-892/PRC-25 (fig. 1-2) is "provided with a spring base to permit positioning the antenna other than vertically to the top of the receiver-transmitter. For beat communication, the antenna should be vertical to the ground (A and B, fig. 2-6). When the operator or the receiver-transmitter is in a position other than vertical, the antenna should be adjusted so that it is vertical to the ground. If the vertical position would reveal the operator's location, the antenna can be positioned so that it is horizontal to the ground (C, fig. 2-5). Under this situation, the direction of communication is broadside to the antenna.

**Caution:** If as little as one-sixteenth inch gap is allowed between the top of the whip antenna mount and the flat bottom of the antenna the antenna may break at this point leaving the threaded portion in the antenna mount. A plastic filling has been included among the threads but it may become worn and ineffective in preventing the antenna from being unscrewed by vibration. To safeguard the antenna periodically tighten it into the antenna mount.

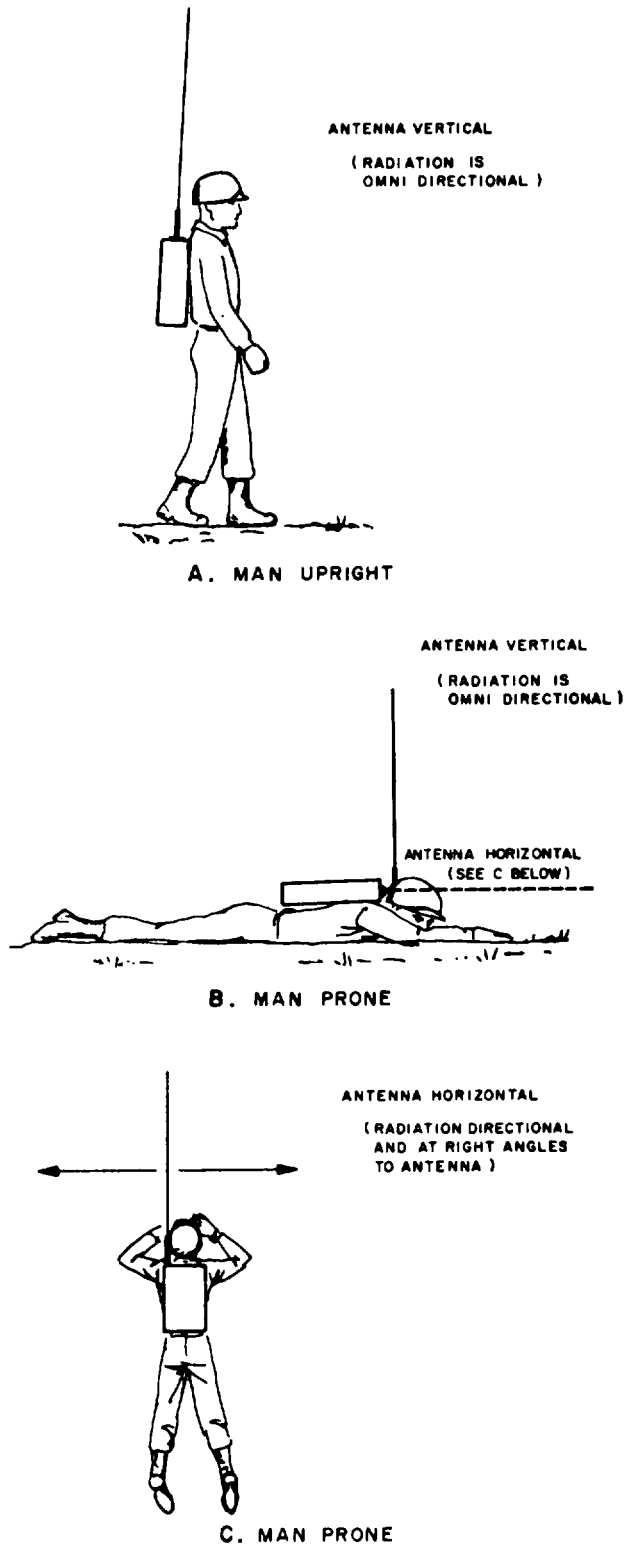

Figure 2-5. Orientation of AT-892/PRC-25 in various positions on user

**CHAPTER 3**  
**OPERATING INSTRUCTIONS**

---

**CAUTIONS**

1. When an AN/PRC-25 is used less than 10 feet from Radio Sets AN/VRC-12 and AN/VRC-43 through -49, and similar radios that use Receiver-Transmitters, Radio RT-246/VRC and RT-524/VRC, there is danger that the high transmitter power of these radio sets can damage 1st RF amplifier module A3 in the receive circuit of the RT-505/PRC-25, even when it is turned off, unless module A3 has the words *CR1 MOD ADDED* on its cover, or unless module A33 is used. Accordingly, keep the AN/PRC-25 away from these high power radio sets until the "unprotected" module A3 has been replaced with either one that has the words *CR1 MOD ADDED* on its cover or one that is marked A33. (Module A33 is the version used in RT-841/PRC-77 and may also be installed in the RT-505/PRC-25).

2. Do NOT change the mc and kc tuning controls or the BAND switch while the radio is keyed for transmission (handset push-to-talk switch depressed). Damage to modules in the radio may result or the wrong channel frequency may be set up, thus preventing radio communication.

3. Battery power should be between 12.5 and 15 volts dc, with plus (+) applied to the B terminal on the battery connector (at the back of the receiver-transmitter) and minus (-) applied to the A terminal. Do not interchange these battery polarities; to do so results in damage to modules in the radio.

**3-1. Receiver-Transmitter, Radio RT-505/PRC-25, Controls, Indicators, and Connectors**  
(fig. 3-1)

Control, Indicator or Connector	S W position	Function
		Action
Function switch-----	OFF-----	Turns off power.
	ON-----	Applies power.
	SQUELCH-----	Applies power and <i>stops</i> rushing noise when no radio signal is received.
	RETRANS-----	Permits radio relay operation.
	LITE-----	Spring-loaded position; lights channel dial.
BAND switch - - - - -	30-52-----	Selects lower frequency band, A band.
	53-75-----	Selects higher frequency band, B band.

MC tuning control-----	Tune radio in 1-mc steps as indicated by channel dial.
Kc tuning control-----	Tunes radio in 50-kc steps as indicated by channel dial.
REC-TRANS FREQUENCY dial-----	Indicates operating frequency in mc and kc.
PRESET levers-----	Permit rapid location of two preset frequencies.
VOLUME control-----	Varies receiver volume-
AUDIO connectors-----	Provide connations for handset or retransmission cable.
ANT mount <sup>a</sup> -----	Provides connection for Antenna AT-271A/PRC or AT-892/PRC-25.
ANT connector (BNC) <sup>a</sup> -----	Pmvida connection for freed ground-plane or vehicular antenna (50-ohm impedance).
POWER connector-----	Provides connection for external power supply when RT-505/PRC-25 is used as part of vehicular radio set configurations. When RT-505/PRC-77 uses battery in CY-2562/PRC-25 (fig. 2-2), the radio will not operate if the cover for the POWER connector <i>is</i> not in place.

<sup>a</sup>Other antennas may be used. See paragraphs 6-3, and 6-4, and 6-5.

**3-2. Presetting Channel Frequencies**  
(fig. 3-1 and 3-2)

On the mc and kc controls (fig. 3-1) are pre-set levers that can be set to catch the stops on each control (fig. 3-2 ). Thus, when two channels are preset, they can be selected without looking at the channel dial (fig. 3-1). Use the procedures in a below to set the kc control; use the procedures in b below to set the mc control.

**NOTE**

When presetting the controls, the two frequencies to be set must be considered the lower and the higher frequencies; and the sections of each tuning control as the inner (next to the front panel ) and the outer sections (fig. 3-2).

a. *Presetting Kc Tuning Control.* The kc control is set before the mc control (b, below). Determine the lower and higher kc frequencies.

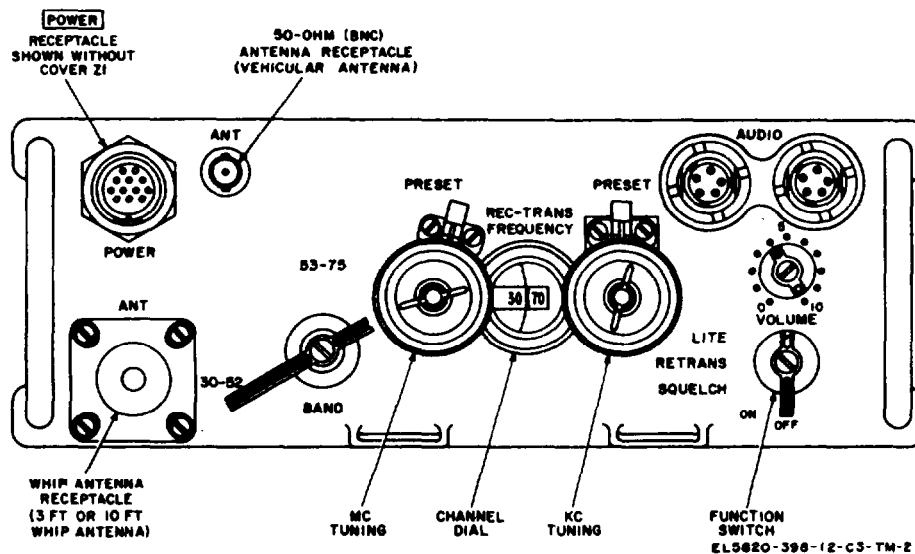

Figure 3-1. Receiver -transmitter, controls, indicator, and connectors.

(For example: 35 in 59.35 mc, 70 in 39.70 mc, etc).

(1) Set the preset lever away from the kc control (A and B, fig. 3-2).

(2) Set the kc control so that the lower frequency appears on the channel dial.

(3) Position the preset lever forward against the control (C, fig. 3-2) and loosen the wingnut on the control.

(4) Pull up on the lower section of the control and turn it counterclockwise until the stop on the lower section strikes the preset lever. Tighten the wingnut.

(5) Position the preset lever away from the control.

(6) Turn the control until the higher frequency appears in the channel dial (both sections move).

(7) Loosen the wingnut and position the preset lever forward against the control.

(8) Without disturbing the setting of the lower section, pull *on* the upper section and turn it clockwise until its stop strikes the preset lever.

(9) Keeping the upper section against the preset lever, tighten the wingnut.

(10) Check the settings for the lower and higher kc frequency settings by turning the control counterclockwise to the stop for the lower kc frequency, and clockwise to the stop for the higher kc frequency.

(11) Set the *mc* control (b below).

*b. Presetting Mc Tuning Control.* The *mc* control is set after the *kc* control (a above). Determine the assigned lower and higher *mc* frequencies. (For example: 59 in 59.35 *mc*, 39 in 39.70 *mc*, etc).

(1) *Presetting mc frequencies in same band.* The procedure for presetting the lower and upper sections of the *mc* control for *mc* frequencies *that are in the same band* are the same as those given for the *kc* control in a above. That is, the lower *mc* frequency in the band is set with the lower section of the control; and the higher *mc* frequency in the same band is set with the upper section.

(2) *Presetting mc frequencies in different bands.* Note that there are 23 positions of the control in each band: from 30 through 52 in band A; from 53 through 75 in band B.

(a) When presetting the *mc* control for frequencies that are in *different bands*, always set the lower section to that *mc* frequency that is lower in its *band* than the *mc* frequency in the other band. *For example: 54 is lower (second position) in band B than 33 mc (fourth position) in band A; thus, 54 mc would be set on the lower section and 33 mc would be set on the upper section.*

(b) To preset the *mc* control sections, use the same procedures in a above with the band switch in the proper position and with the band switch in the proper position and with the information given in (a) above.

### 3-3. Selecting Preset Channels

(fig. 3-1 and 3-2)

To select a preset channel, proceed as follows:

a. Set the PRESET levers forward (toward the *mc* and *kc* tuning controls).

b. Set the BAND switch at 30-52 or 53-75, depending on the channel used.

c. Turn the *mc* and *kc* tuning controls until the stops strike against the PRESET levers.

d. Check the channel number that appears in the channel dial.

e. If the incorrect channel appears in the channel dial, turn the tuning controls against the stop in the opposite direction.

f. If the incorrect channel still appears, perform the presetting procedures as given in paragraph 3-2.

g. To select the other preset channel, turn the *mc* and *kc* tuning controls against the other stops. If the preset frequency is in the other band, set the BAND switch at the other position.

### 3-4. Operating Procedure

(fig. 3-1)

a. Set the function switch to ON. A rushing noise should be heard in the handset.

b. Set the BAND switch at 30-52 or 53-75, depending on the channel used.

#### NOTE

If a preset channel is to be used, select the preset channel as given in paragraph 3-3 in place of the procedure in c below. If a preset channel is not

to be used, make sure that the PRE-SET levers are back (away from the mc and kc tuning controls).

Do not change frequencies or the BAND switch while the radio is keyed (in transit mode).

When using magnesium Battery, Dry BA-4386/U, wait approximately 10 seconds after turning on the radio before transmitting (e below) to allow the battery to develop full power.

To obtain best operating range (distance), keep the whip antenna vertical to the ground. See figure 2-5 for various positions the user can position himself/herself to keep the short antenna vertical.

c. Turn the mc and kc tuning controls to display the desired frequency in the channel dial. See procedures in paragraph 3-3 to select preset channels.

d. Set the VOLUME control at position 4; readjust for a desired sound level *in* the handset.

e. Transmit as follows:

- (1) Press the handset push-to-talk switch.
- (2) Speak into the handset.

**NOTE**

Do not speak into both elements of the handset. It has two microphone elements for noise cancellation; speaking into both elements will cancel out the speaker's voice.

f. To receive, release the handset push-to-talk switch.

g. The receiver rushing noise can be stopped or reduced by setting the function switch to SQUELCH during periods when the other station is not transmitting. Refer to paragraph 3-10 for squelch operation conditions. To determine whether squelch operation is possible, use the following procedures:

- (1) Arrange for the distant station to send a short transmission while operating *without its squelch*.

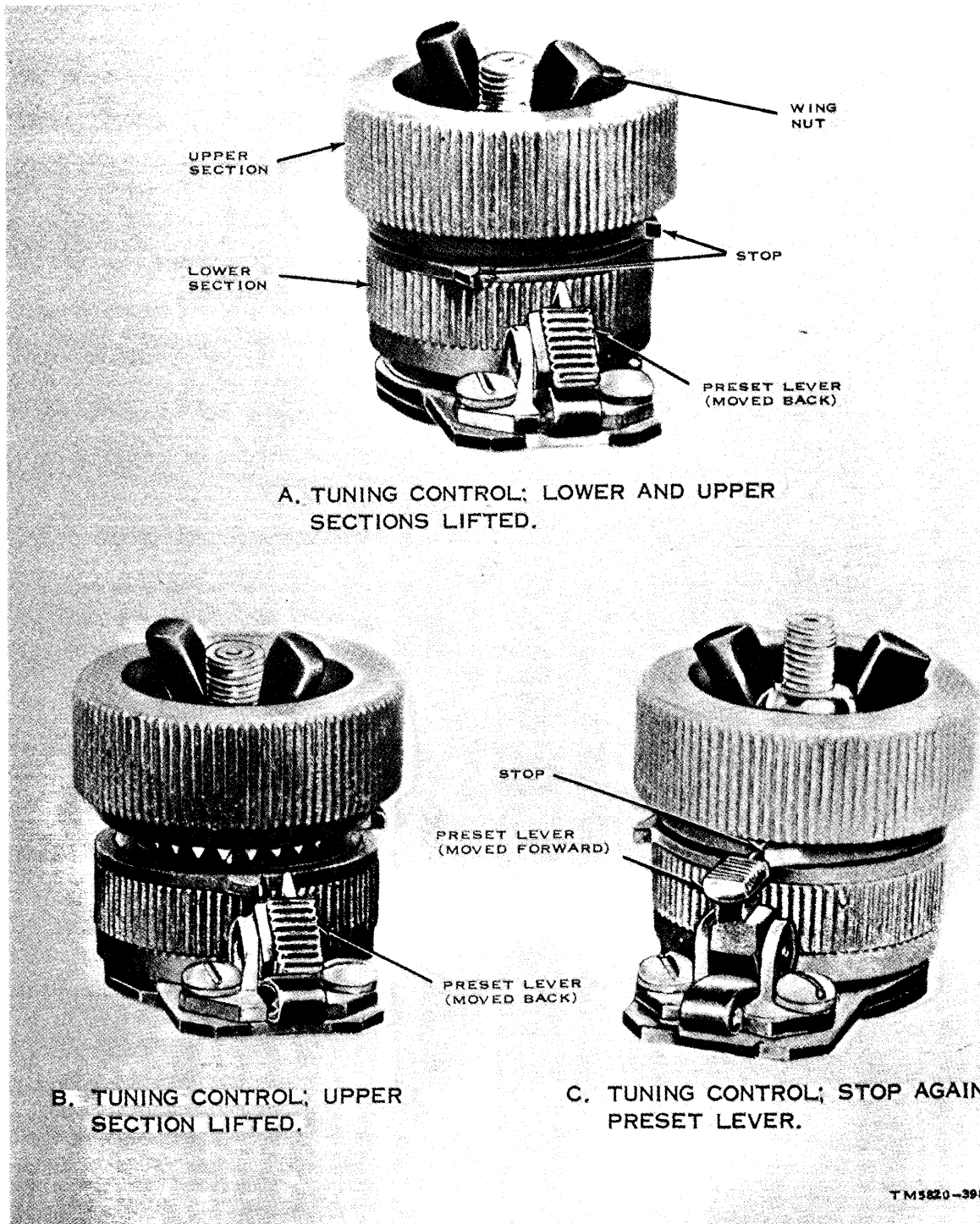

A. TUNING CONTROL; LOWER AND UPPER SECTIONS LIFTED.

B. TUNING CONTROL; UPPER SECTION LIFTED.

C. TUNING CONTROL; STOP AGAINST PRESET LEVER.

TM11820-398-10-11

Figure 3-2. Presetting mc and kc tuning controls





(2) Set the function switch to ON; the rushing noise should be heard until the other station transmits.

(3) Arrange with the other station to turn its squelch switch to the ON position and to send a short transmission.

(4) On the RT-505/PRC-25 (receiver-transmitter), set the function switch to SQUELCH; the rushing noise should stop and the distant station should be heard when it transmits.

(5) If the other station cannot be heard now, reset the function switch to ON and advise the other station of the situation.

*Note.* The failure of either station to receive transmissions from the other may indicate that the distance between the two stations is too great or that the squelch circuit of either radio station is defective.

(6) If either station is moving about, leave the function switches in the ON position at both stations until it has been determined (by using the procedures in (1) through (5) above) that reception can be accomplished with the function switch at SQUELCH.

### 3-5. Stopping Procedure

(fig. 1-2 and 3-1)

a. To stop the AN/PRC-25, set the function switch to OFF.

b. If the AT-271A/PRC was used, disassemble it as follows:

(1) Unscrew the AT-271A/PRC from the AB-591/PRC-25.

(2) Beginning with the top section, pull out each section from the next section and fold it along the side of the next lower section.

(3) Unscrew the AB-591/PRC-25 from the antenna mount.

c. Store the handset, both antennas, and the AB-591/PRC-25 in the CW-503/PRC-25.

d. Close the flaps on the CW-503/PRC-25.

### 3-6. Recognition and Identification of Jamming

Under real or simulated tactical conditions, the receiver may be jammed by the enemy. Jamming is easily done by transmission of a strong signal on the frequency being used, which makes it difficult or impossible to hear

the desired signal. Unusual noises or strong interference heard on the receiver may be enemy jamming, signals from a friendly station, noise from a local source, or a defective receiver. To determine whether the interference is originating in the receiver, disconnect the antenna. If the interference continues, the receiver is defective.

### 3-7. Anti-jamming

When jamming of a channel is first noticed, notify your superior officer immediately and continue to operate the equipment. To provide maximum intelligibility of jammed signals, try the suggestions given in a through c below.

a. The effects of enemy jamming may be reduced by placing the equipment so that nearby obstructions act as a screen in the direction of probable sites of enemy jamming transmitters. This screen action may also reduce the transmitted signal strength toward the enemy and thereby make it more difficult for him to intercept your signals. If possible, try several different locations within the designated area and stay at the one where jamming is minimum.

b. Vary the VOLUME control. The level of the desired signal may be raised enough to be distinguished from the jamming signal.

c. If the procedures in a and b above do not provide sufficient signal separation for operation, request change to an alternate frequency and call sign.

### 3-8. Operating Procedures Under Arctic Conditions

When operating the AN/PRC-25 under arctic conditions, Battery, Dry BA-398/U (para 6-2) must be used instead of the BA-386/U or BA-4386/U. The BA-398/U (fig. 6-3), which is worn beneath the operator's parka, allows operation in temperatures to -63°F. (-53°C.). Prior to operation in extreme temperatures, check to see that a coating of silicon grease has been applied to the neoprene rubber O-rings of the audio connectors. See SB11-576 for AN/PRC-25 arctic batteries

### 3-9. Homing Operation

Use Antenna, Homing Loop AT-784/PRC (TM 11-5985-284-15) to provide the AN/

PRC-25 with facilities for homing operation. Refer to paragraph 6-4 for operation of the AT-784/PRC with the AN/PRC-25.

**3-10. Conditions for Squelch and Nonsquelch Operation**

The explanations and squelch operating conditions in *a* through *d* below are applicable to the squelch operation in paragraph 3-4g.

*a.* When the function switch of the RT-505/PRC-25 is set to ON, a rushing noise is heard in the handset. The rushing noise stops when the RT-505/PRC-25 or another transmitter operating on the same frequency is turned on.

*b.* When the function switch is set to SQUELCH, no sound is heard in the handset until the RT-505/PRC-25, or another transmitter operating on the same frequency, is turned on, provided the other transmitter transmits a 150-cps squelch signal when it is turned on, Radios provided with this feature are given in *c* below. When the RT-505/PRC-25 is turned on for transmission with its function switch set to SQUELCH, a 150-cps squelch signal is transmitted; it is heard as a sidetone buzz in the handset.

*c.* Communication with the function switch set to SQUELCH is possible when other stations in the radio net are using one of the following radio sets and *if* these radios *also* have their squelch switches in the on positions. In general, when one of the following radio sets has its squelch switch set to the 150-cps squelch function, the other radio sets in the net must be set similarly.

(1) Radio sets that are equipped with the RT-505/PRC-25, such as Radio Sets AN/PRC-25, AN/VRC-53, AN/VRC-54, and AN/GRC-125.

(2) Radio sets that are equipped with the

Receiver-Transmitter, Radio RT-841/PRC-77, such as Radio Sets AN/PRC-77, AN/VRC-64, and AN/GRC-160. The RT-841/PRC-77 looks like and operates identically to the RT-505/PRC-25.

(3) Radio sets that are equipped with the Receiver-Transmitter, Radios RT-246/VRC, RT-524/VRC, or Receiver, Radio **R-442**/VRC, such as Radio Sets AN/VRC-12, and AN/VRC-43 through AN/VRC-49, and AN/VRG54. The 150-cps squelch tone is transmitted from these radios when their squelch switch is set to NEW ON, NEW OFF, and OLD OFF. When the 150-cps squelch signal is sent from another radio set, these radio sets will respond when their squelch switch is set to NEW ON.

(4) When communication is with Radio Sets AN/ARC-54 and AN/ARC-131, the squelch switch of these radio sets must be set to TONE.

*d.* To communicate with radio sets other than those listed in *c* above, the function switch of the RT-505/PRC-25 must be set to ON.

**3-11. System Application**

Figure 3-3 shows various frequency-modulated (FM) radio sets with which the RT-505/PRC 25 can communicate within the 30-75.95-megacycle (mc) band. The chart below lists the frequency ranges, the channel spacing of the radio sets, and their associated publications. All radios listed, except those in which preset crystals are required, can tune to any frequency within its operating range, Take note of the channel spacing in kilocycles. *For example*, communication with the Radio Set AN/PRC-6 can occur on 50.00 mc, 50.20 mc, 50.40 mc, etc.

Radio Sets	Frequency Range	Publkd.km	R4nmrks
AN/PRC-25 <sup>a</sup> -----	50 kc	TM 11-5820-398-12	
AN/VRC-53, AN/VRC-64, AN/GRC-125, AN/GRC-160. <sup>a</sup>	30-75.95 50 kc	TM 11-5820-498-12	
AN/VRC-54 <sup>a</sup> -----	30-75.95 50 kc		Includes AN/VRC-46, AN/PRC-25, and AN/VRC-24.

Radio Sets	Frequency Range (mc)	Channel spacing; every	Publication	Remarks
AN/VRC-12, AN/VRC-43 through AN/VRC-49 <sup>a</sup> .	30-75.95	50 kc	TM 11-5820-401-10	
AN/ARC-121, AN/ARC-122, AN/ARC-128,	30-75.96	50 kc		
AN/PRC-77 <sup>a</sup> -----	30-75.95	50 kc	TM 11-5820-667-12	Channels provided by preset crystals.
AN/PRC-6-----	47-55.4	200 kc	TM 11-296	
AN/PRC-9-----	30-38.90	100 kc	TM 11-5820-292-10	
AN/PRC-10-----	38-54.9	100 kc	TM 11-5820-292-10	
AN/PRC-28-----	30-42	100 kc	TM 11-5820-292-10	
AN/ARC-44 (modified)---	24-51.90	100 kc	TM 11-5821-204-12	
AN/ARC-54 <sup>a</sup> -----	30-69.95	50 kc	TM 11-5821-244-12	
AN/ARC-131 <sup>a</sup> -----	30-75.95	50 kc	TM 11-58204370-12	Includes AN/VRC-47
AN/GRC-163-----	30-75.95	50 kc	TM 11-5820-713-15	
AN/TSC-61A-----			TM 11-5895-469-15-1	
AN/FSQ-75(V) <sup>b</sup> -----	30-75.95		TM 11-5895-690-10	
AN/TSQ-70A <sup>b</sup> -----			TM 11-5895-579-12	
AN/TSQ-71A <sup>b</sup> -----	30-75.95		TM 11-5895-474-12	
Communications Facility, Mobilized AN/MRC-119 and Communications Facility, Jeep Mounted AN/MRC-120 <sup>a</sup>	30-75.95	50 kc	TM 11-5820-696-15	Both facilities include AN/PRC-25 and AN/PRC 46
Receiver-Transmitter RT-67/GRC in: AN/GRC-5, AN/GRC-6.	27-38-90	100 kc	TM 11-284	
AN/VRQ-2-----			TM 11-287	
AN/VRC-9-----			TM 11-286	
AN/VRC-14-----			TM 11-291	
AN/VRC-17-----			TM 11-611	
AN/VRC-21-----			TM 11-642	
Receiver-Transmitter RT-68/GRC in: AN/GRC-7, AN/GRC-8	38-54.90	100 kc	TM 11-284	
AN/VRQ-3-----			TM 11-287	
AN/VRC-10-----			TM 11-286	
AN/VRC-15-----			TM 11-291	
AN/VRC-18-----			TM 11-611	
AN/VRC-22-----			TM 11-642	
Receiver-Transmitter RT-70/GRC in: AN/GRC-5 through AN/GRC-8.	47-58.40	100 kc	TM 11-290	
AN/VRC-7-----			TM 11-285	
AN/PRR-9 <sup>c</sup> -----	47-57	100 kc	TM 11-5820-549-12	P/o squad radio; can only receiver; one channel provided by preset crystal
AN/PRR-9 (XE-9)-----	47-57	100 kc	TM 11-5820-549-12-1	Same as AN/PRI-9 above
AN/PRT-4 <sup>c</sup> (AN/PRT 4A <sup>a</sup> ) <sup>b</sup>	47-57	100 kc	TM 11-5820-649-12	P/o squad radio; can only transmit; one channel provided by preset crystal

a These radio sets have the 150-cps squelch feature in their receiver-transmitters and receivers that make them compatible with the RT-505/PRC-25 for squelch operation. Refer to paragraph 3-10 for details.

b These are radio configurations in which the AN/VRC-46 or AN/VRC-49 is a component.

c As a pair, these squad radios are identified as Radio Set AN/PRC-88.

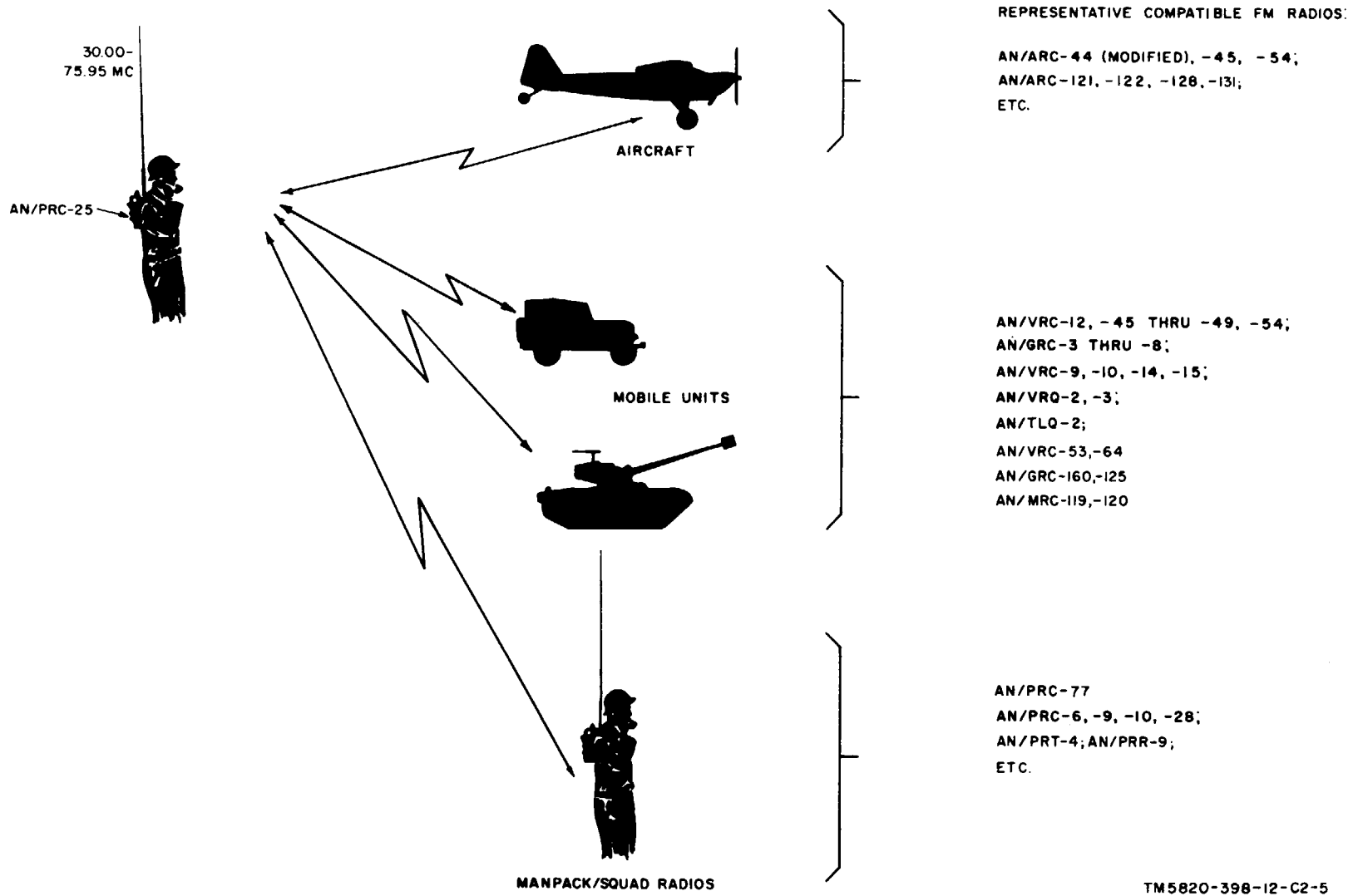

TM 5820-398-12-C2-5

Figure 3-3. Typical radio systems compatible with RT-505/PRC-25, AN/PRC-25.

## CHAPTER 4

OPERATOR'S MAINTENANCE INSTRUCTIONS

---

## Section 1. PREVENTIVE MAINTENANCE

**4-1. Scope of Operator's Maintenance**

No special tools or test equipment are required for operator's maintenance of the AN/PRC-25 Trichloroethane (item 1, app F) is required for cleaning (para 4-3). Operator's maintenance includes the following:

- a. Preventive maintenance (para 4-2, table 4-1).
- b. Replacing the battery (para 2-4).
- c. Troubleshooting ( para 4-4 and 45).

**4-2. Preventive Maintenance, General**

Preventive maintenance is the systematic care, servicing, and inspection of equipment to prevent occurrence of trouble, to reduce downtime, and to assure that the equipment is serviceable. Preventive maintenance checks and services (PMCS) defines procedures to be performed at specific intervals and under certain conditions (table 4-1 ).

- a. Before you operate perform your before (B) PMCS.
- b. While you operate, perform your during

(D) PMCS. The recording and reporting of your during (D) PMCS is done while performing the after (A) PMCS.

c. After you operate, perform your after (A) PMCS.

d. If the equipment was not used during a week, perform the (B), (D), and (A) PMCS together with the weekly (W) PMCS.

e. If the equipment fails to operate, try troubleshooting (para 4-4 and 4-5), If the equipment still fails to operate, submit it to higher maintenance for repair using the proper forms (TM 38-750) .

f. The *Item No.* in table 4-1 shall be used as a source of item numbers for the *TM Number* column on DA Form 2404 (Equipment Inspection and Maintenance Worksheet) in recording the results of the PMCS.

g. If the equipment must be kept in constant operation, check and service only those items that can be checked and serviced without disturbing operation. Make the complete checks and services when the equipment can be shut down.

Table 4-1. Operator's/Crew Preventive Maintenance Checks and Services

NOTE

Within the designated interval, these checks are to be performed in the order listed.

B- BEFORE OPERATION      D- DURING OPERATION      A- AFTER OPERATION      W- WEEKLY

ITEM No.	INTERVAL				ITEM TO BE INSPECTED	PROCEDURES CHECK AND HAVE REPAIRED OR ADJUSTED AS NECESSARY	FOR READINESS REPORTING EQUIPMENT IS NOT READY/AVAILABLE IF:
	B	D	A	W			
1					Completeness	All components are on hand to make the radio operation (appx B) ; that is to communicate.	Operational component(s) is (are) not available.
2					Operation	<p>While operating the radio, check the following features:</p> <ul style="list-style-type: none"> <li>a. Switches and controls (1) and (2) are not loose in their shafts.</li> <li>b. VOLUME control ( 1 ) does not bind and there is no interruption of received signal as control is rotated through its range .</li> </ul>  <ul style="list-style-type: none"> <li>c. Squelch operation is satisfactory (para 3-10), if used.</li> <li>d. Communications is not intermittent.</li> <li>e. Under normal conditions (based on experience with antenna being used, terrain, distance to other radios, assigned operating frequencies, etc. ) , communication can be conducted.</li> </ul>	
3			0		Battery	<ul style="list-style-type: none"> <li>a. Remove battery (para 2-4) i f radio set will not be used again that day or longer.</li> <li>b. Check to see that the battery case (1) is not swollen [bulging] , or leaking, and that the contact receptacle (2) is not damaged.</li> </ul> 	

Table 4-1. Operator's/Crew Preventive Maintenance Checks and Services - Continued.

NOTE  
 Within the designated interval, these checks are to be performed in the order listed.

B- BEFORE OPERATION      D- DURING OPERATION      A- AFTER OPERATION      W- WEEKLY

ITEM NO.	INTERVAL				ITEM TO BE INSPECTED	PROCEDURES CHECK AND HAVE REPAIRED OR ADJUSTED AS NECESSARY	FOR READINESS REPORTING EQUIPMENT IS NOT READY/AVAILABLE IF:
	B	D	A	W			
4				o	Antennas	<p>Check the following on the antenna being used:</p> <ul style="list-style-type: none"> <li>a. The threads (3) on the ends of the sections can be are not damaged.</li> <li>b. The spring section (2) screwed down fully without a gap (4).</li> <li>c. The upper section (1) and spring section (2) can be screwed together fully.</li> </ul>	
5				o	Handset	<p>Perform the following:</p> <ul style="list-style-type: none"> <li>a. Check to see that:                             <ul style="list-style-type: none"> <li>(1) Handset case (1) is not cracked.</li> <li>(2) Cord (2) is not cut, wires are not exposed, and it coils up.</li> <li>(3) Switch cover (rubber) (3) is in place and not cut.</li> <li>(4) O-ring (5) is in place and is not loose in its groove.</li> <li>(5) Handset connector locks firmly on radio connector (4).</li> </ul> </li> <li>b. Clean connector (6) contacts (para 4-3d).</li> </ul>	

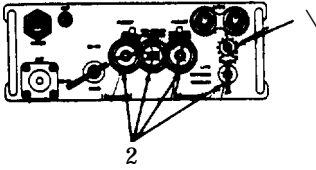
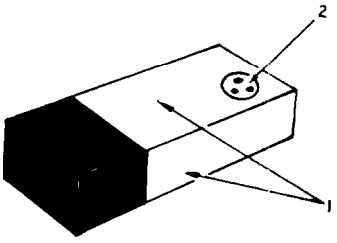
Table 4-1. Operator's/Crew Preventive Maintenance Checks and Services - Continued.

NOTE  
 Within the designated interval, these checks are to be performed in the order listed.

B- BEFORE OPERATION      D- DURING OPERATION      A- AFTER OPERATION      W- WEEKLY

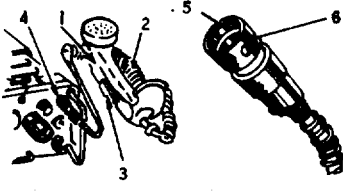
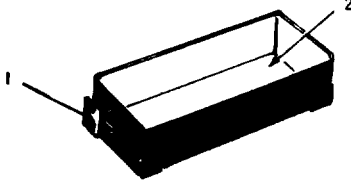
ITEM NO.	INTERVAL				ITEM TO BE INSPECTED	PROCEDURES CHECK AND HAVE REPAIRED OR ADJUSTED AS NECESSARY	FOR READINESS REPORTING EQUIPMENT IS NOT READY/AVAILABLE IF:
	B	D	A	W			
6			o		CY-2562/PRC-25	<p style="text-align: center;"><b>HANDSET CONNECTOR</b></p>  <p>Perform the following:</p> <ul style="list-style-type: none"> <li>a. Tighten the pressure relief valve (1) if loose.</li> <li>b. Clean the inside (2) of the cover (para 4- and b).</li> <li>c. If there is evidence of leakage from the battery, replace the battery (item 2 above).</li> </ul> 	



**4-3. Cleaning**

The surface of the equipment should be clean; that is, there should be no dirt, grease, oil or fungus on the surfaces.

**WARNING**

Fumes of TRICHLOROTRIFLUOROETHANE are poisonous. Provide adequate ventilation whenever you use TRICHLOROTRIFLUOROETHANE. Do not use solvent near heat or open flame. TRICHLOROTRIFLUOROETHANE will not burn, but heat changes the gas into poisonous, irritating fumes. DO NOT breathe the fumes or vapors. TRICHLOROTRIFLUOROETHANE dissolves natural skin oils. DO NOT get the solvent on your skin. Use gloves, sleeves, and an apron which the solvent cannot penetrate. If the solvent is taken internally, consult a physician immediately.

a. Remove dust and dirt with a clean cloth. If dirt is difficult to remove, dampen the cloth with water; soap may be used for more effective cleaning.

b. Remove grease, oil, fungus, and ground-in dirt with a cloth dampened (not wet) with trichlorotrifluoroethane.

c. Clean the canvas items (CW-503/PRC-25 and ST-138/PRC-25 (fig. 2-3)) with a brush moistened with trichlorotrifluoroethane.

d. Clean the contacts of the RT-841/PRC-77 AUDIO connector (fig. 3-1) and the handset connector (fig. 1-4) with a pencil eraser.

**Section II. TROUBLESHOOTING**

**4-4. Visual Inspection**

a. When the equipment fails in communication check the following items:

(1) Switches and controls are set correctly (para 3-4).

(2) The handset and antenna are secured to the receiver-transmitter.

b. If the above procedures do not clear the trouble, proceed to the troubleshooting chart (para 4-5).

**4-5. Troubleshooting**

The following chart contains procedures an operator can do to try to restore communication. *Any* trouble or defective equipment that cannot be corrected by the operator shall be referred to organizational maintenance (DA Pam 738-750).

**CAUTION**

Do not move the MC and KC tuning controls while the radio is keyed.

Malfunction	Probable Cause	Corrective Action
1. Rushing noise is not heard when function switch is set to ON.	a. POWER connector (item 13, fig. 5-2) is not tightened.	a. Tighten POWER connector.
	b. Defective battery (fig. 2-2).	b. Perform the following: (1) Set function switch to LITE; the dial lamp should light. (2) Key the receiver-transmitter and talk sidetone should be heard. (3) If <i>neither of dove</i> indications is obtained, replace the battery (Para 2-4) and repeat (1) and (2) above.
2. Rushing noise does not stop when function switch is set to SQUELCH.	Defective <i>receiver-transmitter</i> .	Rotate MC and KC controls back and forth a few times.

Malfunction	Probable Cause	Corrective action
<p>3. Communication cannot be conducted with distant terminal on assigned frequency; sidetone is heard on transmission.</p>	<p>a. Defective receiver-transmitter.</p> <p>b. Radio is located in poor location.</p> <p>c. The antenna is loose in its receptacle.</p> <p>d. The distance to the next radio terminal is too great for the short 3-foot Antenna AT-892/PRC-25 (fig. 1-2).</p> <p>e. Defective handset.</p>	<p>a. Perform the following:</p> <p>(1) Rotate the MC and KC controls back and forth a few times.</p> <p>(2) Try alternate frequencies.</p> <p>b. Move to another location; even a few feet may help. Set the antenna vertical.</p> <p>c. Screw the antenna down fully.</p> <p>d. Install the 10foot Antenna AT-271A/PRC (para 2-6b).</p> <p>e. Perform the following</p> <p>(1) Use the other AUDIO connector.</p> <p>(2) Clean the connector contacts (para 4-3d) of both the handset connector and the AUDIO connectors.</p>
<p>4. Unable to communicate in squelch mode (para 3-4g (function switch in SQUELCH position).</p>	<p>a. Distant radio is not compatible.</p> <p>b. Distant radio is compatible for squelch mode operation.</p> <p>c. Radio is located in poor location.</p>	<p>a. If radio with which you are trying to communicate in squelch mode is not one of those identified in footnote a of the radios listed in paragraph 3-11, you must communicate without squelch by setting the function switch to ON.</p> <p>b. If the distant radio is using RT-246/VRC or RT-524/VRC, its SQUELCH switch can be set in any position except OLD ON. If another radio, the 150 cps squelch tone must be switched on.</p> <p>c. Move to another location; even a few feet may help.</p>
<p>5. Reception satisfactory; on transmission, motorboating is heard.</p>	<p>Defective battery.</p>	<p>Replace battery (para 2-4).</p>

<i>Step</i>	<i>Action</i>	<i>Normal indication</i>	<i>Corrective measures</i>
11	Adjust a nearby radio (known to be good) to receive test signals transmitted by RT-505/PRC-25. Set function switch of nearby radio at SQUELCH. Press push-to-talk switch of handset connected to RT-505/PRC-25 and send long voice test signal.	Test signal is heard loud and clear at nearby radio; side tone is heard in handset,	Higher category repair is required. If motorboating is heard on transmission, replace battery.
12	Set function switch to OFF.	Radio stops operating.	Higher category repair is required.

**5-7. Use of Test Sets, Radio Frequency Power AN/URM-182 and TS-2609/U**

The AN/URM-182 consists of Test Set, Radio Frequency Power TS-2609A/U and Cable Assembly RF CG-409G/U stowed in Case, Test Set CY-6785/U. The TS-2609/U is a single unit. (TS-2609(•)/U, is used to identify both units.) The TS-2609(•)/U is a small, 50-ohm impedance, throughline, rf wattmeter that measures forward and reflected rf power, transmitting in the 30- to 70-mc range up to 100 watts. It has little effect on received rf power. To use the TS-2609(•)/U, proceed as follows.

a. Since the TS-2609(•)IU is connected between the coaxial ANT connector and a 50-ohm antenna system or dummy load (not the whip antenna receptacle of the RT-505/PRC-25), the test would only indicate whether the RT-505/PRC-25 has sufficient or insufficient output rf power. If insufficient transmitting power is obtained (b(3) below), communication failure could be attributed to one of the following: Whip antenna defective or not fully screwed into the receptacle; weak battery; defective handset; or defective modulation or demodulation circuits in the radio.

b. Since the TS-2609(•)/U cannot be connected to the whip antenna connector, use a vehicular whip antenna system of another radio set, such

as the AS-1729/VRC (or AT-912/VRC) of the AN/VRC-12 radio series (TM 11-5820401-10-1, TM 11-5820401-10-2, or TM 11-5820401-12), or of Radio Sets AN/VRC-53, AN/VRC-64, AN/GRC-125, AN/GRC-160 (TM 11-5820-498-12). To perform the test, proceed as follows. Refer to TM 11-6625-1686-15 for instructions on connections and operation of the TS-2609/U and to TM 11-6625-2718-14&P for the TS-2609A/U of the AN/URM-182.

**CAUTION**

Never change frequencies of the BAND switch while the transmitter is keyed (by pressing the handset push-to-talk switch). To do so damages modules in the radio or may cause the wrong frequency to be set up for transmission.

(1) Leave the battery in the RT-505/PRC-25 and connect the TS-2609(•)/U between the RT-505/PRC-25 and the vehicular antenna system.

(2) Key the RT-505/PRC-25 at the frequency at which communication fails and at other frequencies in both bands.

(3) Normally forward power indications should range between 0.5 and 3 watts, depending on frequency.

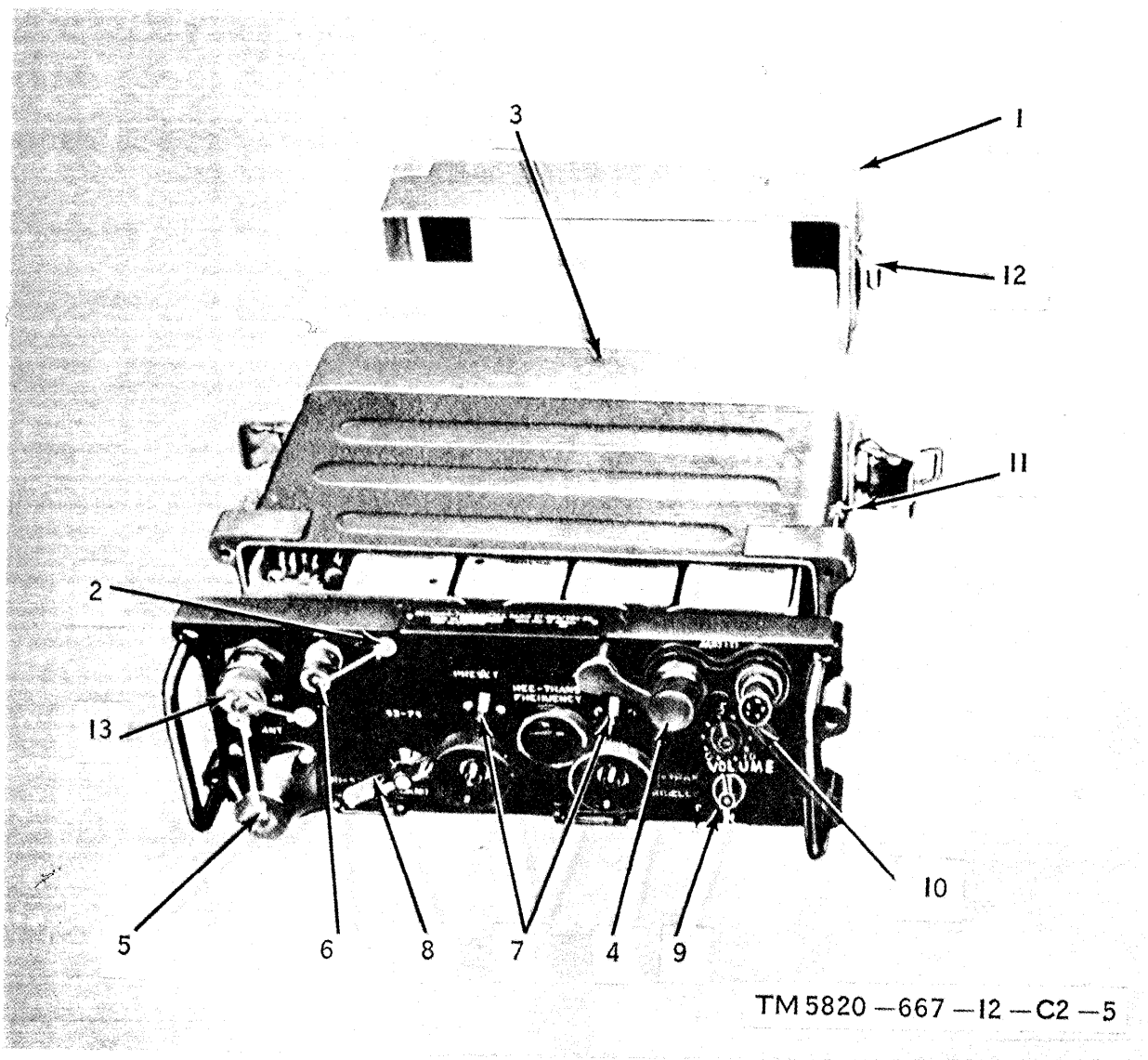

Figure 5-1. Receiver-Transmitter, Radio RT-505/PRC-25, parts.

CHAPTER 5

ORGANIZATIONAL MAINTENANCE

Section 1. GENERAL

5-1. Scope of Organization Maintenance

Organizational maintenance includes preventive maintenance (para 5-3 and table 4-1) and troubleshooting (para 5-4, 5-5, and 5-6).

- a. Multimeter AN/URM-105.
- b. Tool Kit, Electronic Equipment TK-101/G.
- c. Trichlorotrifluoroethane (item 2, app F).
- d. Silicone Compound (item 2, app F).
- e. Graphite Grease, nonseizing compound (item 3, app F).
- f. Epoxy (item 4, app F).
- g. Cleaning cloth.

5-2. Tools, Materials, and Test Equipment Required

Section II. PREVENTIVE MAINTENANCE

5-3. Organizational Preventive Maintenance Checks and Services (PMCS)

Preventive maintenance is the systematic care, inspection, and servicing of equipment to maintain it in serviceable condition, prevent breakdowns, and assure maximum operational capability. Organizational preventive maintenance checks and services (PMCS) are performed quarterly.

scheduled in accordance with the procedures specified in DA-Pam738-750, and performed as indicated in table 5-1.

b. The *Item No.* in table 5-1 shall be used as a source of item numbers for the *TM number* column on DA Form 2404 (Equipment Inspection and Maintenance Worksheet) in recording the results of the PMCS.

c. If the equipment fails to meet the criteria in the *Procedures* column of the table, report the failure in accordance with the procedures specified in DA Pam 738-750.

- a. Quarterly PMCS on the equipment will be

Table 5-1. Organizational Preventive Maintenance Checks and Services-Quarterly Schedule

Item No.	Item to be inspected	Procedure Check for and have repaired or adjusted as necessary
1	Completeness	Check to see that all AN/PRC-25 components are on hand (app 11) or are amounted for (being repaired and/or on requisition).
2	Publications	TM 11-5820-398-12 and TM 11-5820-398-20P are on hand with latest changes; see DA Pam 25-30 current listing,
3	Modifications	Check DA Pam 25-30 to see if any modification work orders (MWO'S) are listed against the AN/PRC-25 or its components. ALL URGENT MWO'S must be applied within the period specified; all NORMAL MWO'S must be scheduled.

Table 5-1. Organizational Preventive Maintenance Checks and Services- Quarterly Schedule-Continued

Item No	Item to be inspected	Procedure Check for and have repaired or adjusted as necessary
4	Metal surfaces	Remove fungus, rust and corrosion. Spot paint bare metal spots. Refer to SB 11-573 and TB 43-0118 for painting instructions.
5	Handset	<ul style="list-style-type: none"> <li>a. The O-ring in the cable connector is not loose or missing.</li> <li>b. Apply a thin coating of silicone compound (item 2, app F) to the O-ring (not to the connector contacts).</li> </ul>
6	RT-505/PRC-25 (fig. 3-2)	<ul style="list-style-type: none"> <li>a. The clamps are not damaged and hold the CY-2562/PRC-25 securely to the radio case.</li> <li>b. The pressure test screw is in place and epoxy (item 4, app F) is applied over the edge of the screw.</li> <li>c. Observe the case to see if there is any evidence of bulging (due possibly to gas exploding inside the case (para 1-8c).</li> <li>d. Check the following front panel parts (fig. 5-2):               <ul style="list-style-type: none"> <li>(1) Electrical connector covers (4, 5, and 6) are attached to the front panel and each cover fits securely on its connector.</li> <li>(2) The dial locks (7) function to lock and release the MC and KC controls (fig. 3-1).</li> </ul> </li> <li>e. Clean out the whip antenna receptacle in the antenna mount (fig. 3-1). Clean out the small drain hole near the base of this antenna mount leading to the threaded antenna receptacle.</li> <li>f. Loosen the front panel captive screws (fig. 2-2), separate the front panel and chassis from the case, and perform the following checks:               <ul style="list-style-type: none"> <li>(1) Using lung power, blow out all parts on both sides of the case (to get rid of gasses that may have accumulated).</li> <li>(2) Inspect the battery connector for the following                   <ul style="list-style-type: none"> <li>(a) A rubber gasket (shaped similarly to the metal ring around the battery connector hole RT-505/PRC-25 case) must be installed on the radio connector. It must be undamaged, be seated flush with the bottom of the connector (inside the four connector mounting screws), and flush with the body of the connector.</li> <li>(b) The two O-rings on the radio connector must be installed and undamaged; that is, they must not be sheared, and each O-ring must be seated, under tension, in its groove.</li> <li>(c) The three radio connector pins are not bent or loose, or otherwise damaged. Put silicone compound around the connector pins in the rear of the connector. Use RTV102, or equivalent.</li> <li>(d) Reinstall the chassis in the case; tighten the three captive screws. There should be no gap or space between the edges of the case and the front panel chassis.</li> </ul> </li> </ul> </li> </ul>

Table 5-1. Organizational Preventive Maintenance Checks and Services-Quarterly Schedule-Continued

Item No.	Item to be inspected	Procedure Check for and have repaired or adjusted as necessary
7	CY-2562/PRC-25 (fig. 2-2)	a. Tighten the pressure relief valve, which must be installed (para 1-8C). b. Apply a light pressure of air to both sides of the pressure relief valve; air should not go through the valve when applied from the outside of the case and should when applied from inside the case. c. Clean out the CY-2562/PRC-25 (para 4-3).
8	AT-892/PRC-25 (fig. 1-2)	a. The bottom section holds the upper section firmly in position when the upper section is bent at various angles. b. Apply a thin coat of graphite grease (item 3, app F) to the threaded connector.
9	AB-591A/PRC (fig. 1-2)	a. The unit is not damaged or distorted. b. Clean out the threaded receptacle and apply a thin coat of graphite grease (item 3, app F) to the threads on both ends of the unit.
10	AT-271/PRC (fig. 1-2)	a. The wire running through the sections is not broken. There is no water in the sections. b. When fully extended and assembled, each section fits into the next section. c. The tip cap is in place. d. The threaded connector is securely attached to the bottom section. e. Apply a thin coat of graphite grease (item 3, app F) to the threaded connectors.
11	ST-138/PRC-25 (fig. 1-2)	a. All metal parts are secured to the canvas assembly. b. Canvas areas are not torn and all straps are attached to the canvas assembly.

**Section III. TROUBLESHOOTING**

**5-4. Visual Inspection**

a. When equipment failure occurs, inspect the equipment carefully for obvious defects. This procedure may avoid further damage. Perform the following checks:

- (1) Switches and controls are set correctly (para 3-4).
- (2) The handset is seated in its connector and the antenna is screwed down completely.
- (3) The battery is properly connected to the radio connector (fig. 2-2). Check the battery by substitution,

b. If above visual checks do not reveal a cause for radio failure, proceed to the equipment performance checks (para 5-5).

**S-5. Equipment Performance Checklist**

a. *General.* Check the performance of the equipment as outlined in the following checklist, Start at the beginning and follow each step in the order given. If suggested corrective measures do not clear the trouble, submit the equipment to higher maintenance category for repair; note on the repair tag the fault and the corrective measures taken.

**5-6. Repair and Replacement Parts**

For AN/PRC-25 repair parts and replacement parts, refer to TM 11-5820-398-20P. For RT-505/PRC-25 parts, refer to TM 11-5820-497-20P.

*b. Check list.*

<i>Step</i>	<i>Action</i>	<i>Normal indication</i>	<i>Corrective measures</i>
1	Install desired antenna in antenna mount.		
2	Connect handset to either AUDIO connector.		
3	Set VOLUME control to 5.		
4	Set function switch to LIFE,	Channel dial lights.	Replace BA-4386/U.
5	Set function switch to ON.	Rushing noise is heard in handset when no signal is received.	a. Connect handset to other AUDIO connector. b. Check handset by substitution. c. Replace battery.
6	Set function switch to SQUELCH.	Rushing noise is not heard in handset.	Higher category repair is required.
7	Set up a nearby radio (known to be good) to transmit on authorized channel in low (30- to 52-mc) band (if possible), and tune RT-505/PRC25 to this channel. Obtain a long voice test signal from nearby radio.	Test signal is received and heard loud and clear.	If received test signal is weak, check antenna and antenna connection.
8	Adjust a nearby radio to transmit on authorized channel in high (53-75 mc) band (if possible), and tune RT-505/PRC25 to this channel. Obtain long voice test signal from nearby radio.	Test signal is heard loud and clear.	Higher category repair is required.
9	Adjust a nearby radio to transmit on channels listed below (if authorized). Obtain long voice test signal on each channel. Tune RT-505/PRC-25 to each channel in order given below: 30.00 mc 30.05 mc 30.10 mc 30.20 mc 30.30 mc 30.40 mc 30.50 mc 30.60 mc 30.70 mc 30.80 mc 30.90 mc	Test signal is heard loud and clear on each channel.	Record channels not received. Higher category repair is required.
10	Adjust a nearby radio (known to be good) to receive test signals transmitted by RT-505/PRC-25. Press push-to-talk switch of handset connected to RT-505/PRC-25 and send long voice test signal.	Test signal is heard loud and clear at nearby radio; sidetone is heard in Handset.	a. Check handset by substitution. If signal cannot be received at all, higher category repair is required. b. Tune nearby radio to several channels on both sides of operating channel. If signal is received off channel, higher category repair is required.



## CHAPTER 6

## MATERIEL USED IN CONJUNCTION WITH RADIO SET

## AN/PRC-25

**6-1. Radio Relay Procedures and Retransmission Cable Kit MK-456(\*)GRC<sup>a</sup>**

With Cable Assembly, Special Purpose, Electrical CX-4656/GRC from Retransmission Cable Kit MK-456/GRC (fig. 6-1), two compatible FM radios may be used as a radio relay for other radio sets that are too far distant to communicate directly with each other. The radio relay can be accomplished by interconnecting the radios listed in paragraph 3-10c(1) through (3) with the CX-4656/GRC as shown in figure 6-2.

a. MK-456(\*)/GRC. The kit 6-1 and 6-1.1) consists of Bag, Cotton Duck CW-502/PRC and 50-foot cable assembly CX-4656/GRC. The network box has an audio connector to which a handset or audio accessory is attached to monitor (listen to) the signals being retransmitted in one direction.

b. *Selection of Frequencies*

(1) *Interference problems.* When frequencies that are to be used for retransmission are planned, the two frequencies must be at least 3 mc apart and must be selected so that the transmitter of neither radio will interfere with the receiver of the other, as shown in the retransmission interference chart (fig. 7-1 ),

(2) *Use of interference chart.* Each square on the retransmission interference chart (fig. 7-1) represents the intersection of two frequencies. The transmitter frequency is in mc and is plotted from left to right; the receiver frequency is in mc and is plotted from bottom to top. The black areas represent frequencies at which interference will occur; the white areas represent frequencies at which interference will not occur. There are five channels per square of the chart. Examples of

use of the chart are given in (a) and (b) below.

(a) A transmitter frequency of 54 mc will not interfere with a receiver frequency of 32 mc.

(b) A transmitter frequency of 54 mc will interfere with a receiver frequency of 31 mc.

Note. Trial and error checks may disclose that frequencies other than those given in the chart (fig. 7-1) are interfering frequencies. Record these frequencies for future use.

c. *Retransmission Requirements.* Figure 6-2 shows the connections between an AN/PRC 26 (radio set No. 2) and another radio set at the relay site. The chart in figure 6-2 shows the settings of the squelch-functioning switches required at the various sets in the radio net. In general, the relay site radios must operate with squelch signals being received from the distant radios (radio sets No. 1 and No. 4). Refer to paragraph 3-10c(1) through (3) and figure 3-3 for FM radios that can communicate with each other in a radio net.

d. *System Lineup.* Refer to figure 6-2 for the discussion in (1) through (9) below.

(1) Set up each radio at the relay site and at the distant radio sets to operate *without* squelch.

(2) Set the operating frequency of radio sets No. 1 and No. 2 on the same frequency, F1. Set the operating frequency of radio sets No. 3 and No. 4 on another frequency, F2 (b above).

(3) Establish communication between radio sets No. 1 and No. 2 and between radio sets No. 3 and No. 4.

<sup>a</sup>MK-456(\*)/GRC represents MK-456/GRC and MK-456A/GRC. TM 11-5995-202-15 contains operating and maintenance information for the kit. The MK-456A/GRC includes CW-502/GRC and CX-4656A/GRC; the MK-456/GRC includes CW-502/GRC and CX-4656/GRC. All references to MK-456/GRC and CX-4656/GRC apply also to MK-456A/GRC and CX-4656A/GRC.

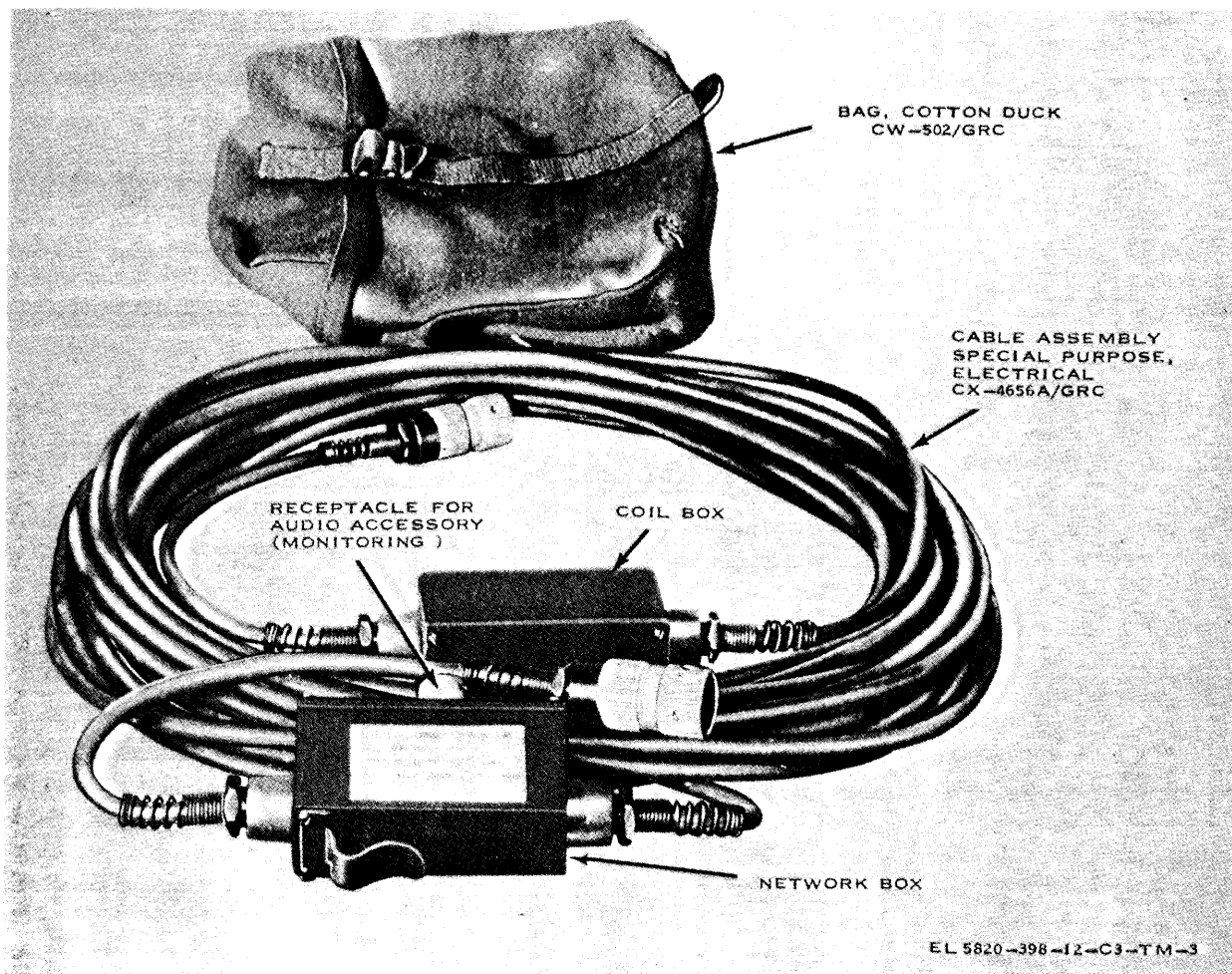

Figure 6-1. Retrasmision Cable Kit MK-456A/GRC.

(4) When communication is satisfactorily established between the associated radio sets, adjust each radio to operate on squelch (see chart, fig. 6-2). Check for satisfactory communication on squelch operation between the *associated pairs* of radio sets (No. 1 and No. 2; No. 3 and No. 4).

(5) When operation on squelch between the radio sets is satisfactory, advise the radio operators at radio sets No. 1 and No. 4 to standby while the following arrangements are being made:

(a) When the RT-505/PRC-25 at the relay site is connected in retransmission to another RT-505/PRC-25 or an RT-841/PRC-77,

connect the connectors on the ends of the CX-4656/GRC to an AUDIO connector on each receiver-transmitter. On each receiver-transmitter, set the function switch to RETRANS.

(b) When the RT-505/PRC-25 at the relay site is connected for retransmission to the RT-246/VRC or RT-524/VRC of the AN/VRC-12 radio series, connect one end of the CX-4656/GRC to an AUDIO connector of the RT-505/PRC-25 and connect the other end of the CX-4656/GRC to the RETRANSMIT R/W connector of the R-246/VRC or RT-524/VRC. Set the function switch of the RT-505/PRC-25 to RETRANS. Set the SQUELCH

Change 3 6-3

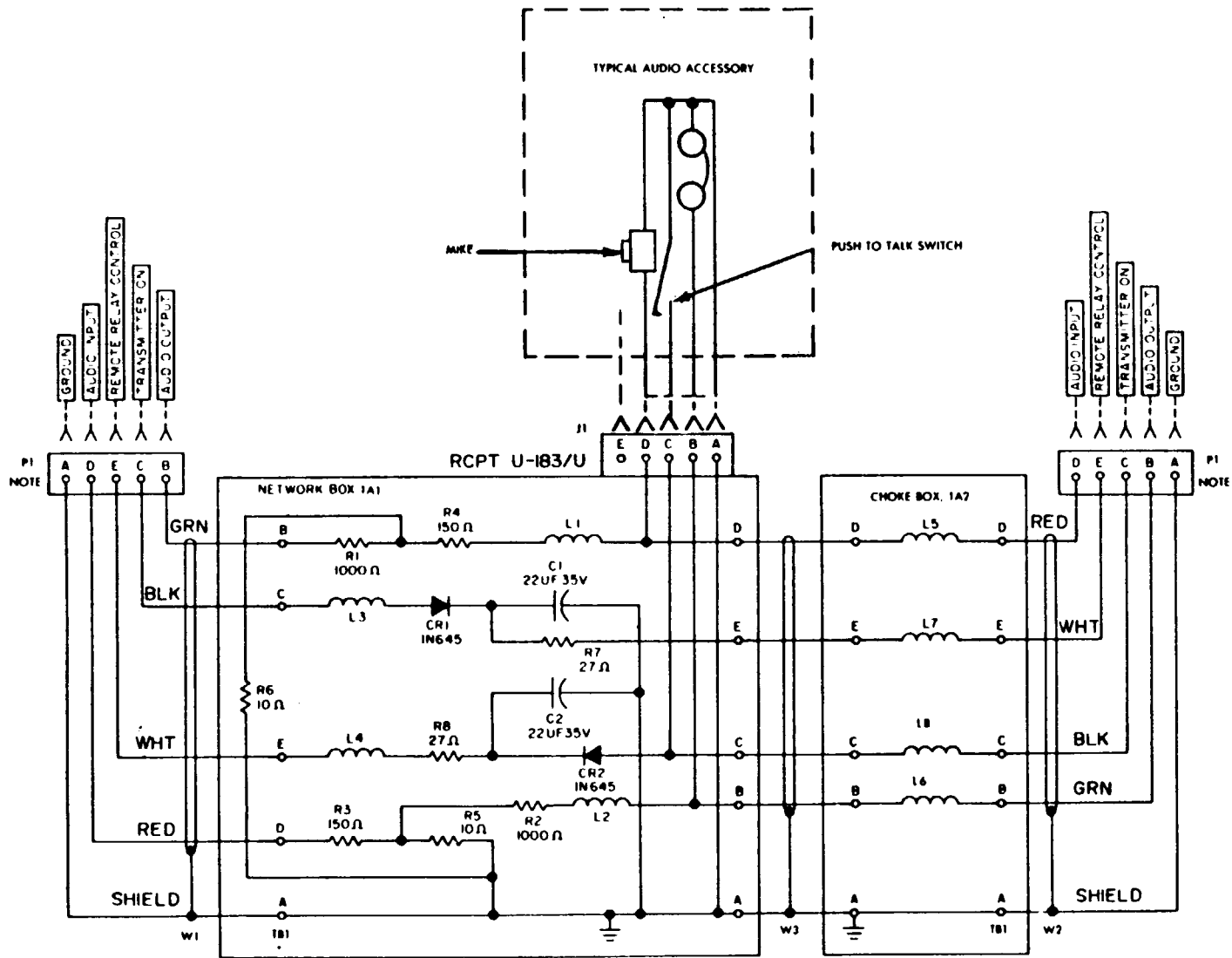

NOTE:

CONNECTOR, PLUG U-182/U IS USED IN CX-4656/GRC;  
CONNECTOR, PLUG U-229/U IS USED IN CX-4656A/GRC.

EL5995-202-15-TM-5

Figure 6-1.1. Cable Assembly, Special Purpose, Electrical CX-4656/GRC or CX-4656A/GRC, (part of MK-456/GRC or MK-456A/GRC), schematic diagram.

TM 11-5820-398-12

switch of the RT-246/VRC or RT-524/VRC to NEW ON when the radio set with which it communicates is one of those given in paragraph 3-10c(1) through (4); set the SQUELCH switch to OLD ON for any other radio set

(6) Communicate with radio set No. 1 from radio set No. 2, and advise the radio set No. 1 operator that the relay site is prepared for communication with radio set No. 4

(7) Communicate with radio set No. 4 from radio set No. 3, and advise the radio set No. 4 operator that the relay site is prepared for communication with radio set No. 1

(8) Communication proceeds automatically between radio sets No. 1 and No. 4 with out any operation required at the relay site.

(9) For the operator at the relay site to communicate with radio set No. 4 connect a handset to the audio connector in the network box (fig. 6-I and 6-1.1). To communicate with radio set No. 1, connect the handset to radio set No. 2 (which is the one that is next to the network box ).

**6.2. Battery, Dry BA-398/U for Arctic Operation**  
(fig. 6-3)

Battery, Dry BA-398/U is used in place of

Battery, Dry BA-386/PRC-25, BA-4386/U to supply power for the AN/PRC25 during arctic operation. The BA-398/U consists of battery units within a carrying vest. Cable Assembly, Special Purpose, Electrical CX-

8808/G is not issued as part of the BA-398/N; it is required to connect the BA-398/U to the RT-50S/PRC25 POWER connector. Before operation, the BA-398/U and vest must be warmed up at temperature above freezing for approximately 8 hours. The average life of the BA-398/U under arctic conditions, when used properly, is approximately 17 hours. See SB 11-576 (Apr 1969) for battery authorization,

**6-3. Antenna Equipment RC-292**

**WARNING**

Operators must be familiar with the requirements of TB Sig 291 and the warnings in the front of this manual. Failure to do so can result in DEATH should an antenna contact any power lines.

Antenna Equipment RC-292 is an elevated, ground-plane antenna that may be used to extend the operating distance of numerous radios including the AN/PRC25 when it is used at a fixed location. The RC-292 is used instead of the antenna that is issued with the AN/PRC25 and is connected to the RF cable ANT connector of the RT-505/PRC25 (fig. 3-1). Installation instructions for the RC-292 are contained in TM 11-5820-34%15. Operation of the radio set is unchanged (para 3-2 through 3-5). The number of RC-292 elements required for the vertical and ground-plane sections for a given frequency band are as given in the chart below.

Operating frequency (mc)	No. of vertical sections required	Type of antenna section used				No. of ground-plane sections required for all legs	Type of ground-plane section used in each leg			
		AB-01/GR	AB-02/GR	AB-03/GR	AB-04/GR		AB-01/GR	AB-02/GR	AB-03/GR	AB-04/GR
30 to 35.5	4	1	1	1	1	2	1	1	1	
36.5 to 50.5	3	0	1	1	1	12	1	1	1	
50.5 to 75.95	2	0	1	0	1	9	0	1	1	

**6-4. Antenna, Homing Loop AT-784/PRC**  
(fig. 6-4)

Antenna, Homing Loop AT-784/PRC is used for detection and location of radio signal in the 30- to 76-mc range. It consists of the components shown in figure 6-4. Cable Assembly, Radio Frequency CG-3344/PRC in for connecting the radio set and Antenna AT-1082/

PRC. Cap, Electrical CW-922/GRC, which is attached to the CG-3344/PRC, is used as a grounding cap and must be connected to the 3- and 10-foot whip antenna connectors. The CW-922/GRC is used to prevent possible radiofrequency radiation from this antenna connector from interfering with the sensing operation of the AT-1082/PRC. Cable Assem-



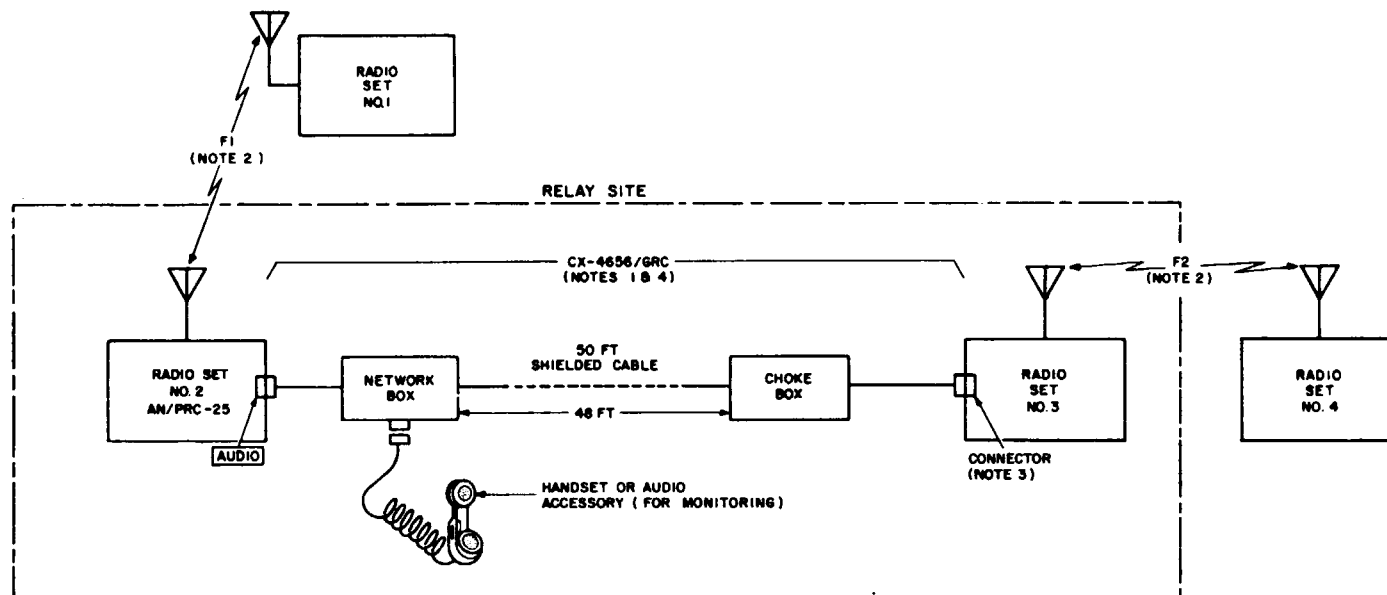

NOTES:

1. PART OF MK-456/GRC.
2. FREQUENCIES FOR F1 AND F2 ARE SELECTED FOR NON-INTERFERENCE.
3. WHEN RT-505/PRC-25 OR RT-841/PRC-77 IS USED, CONNECT CABLE TO **AUDIO** CONNECTOR; WHEN RT-246/VRC OR RT-524/VRC IS USED, CONNECT CABLE TO **RETRANSMIT R/W** CONNECTOR.
4. RADIO SETS NO. 2 AND NO. 3 AT RELAY SITE SEPARATED BY FULL LENGTH (50 FT) OF CX-4656/GRC.
5. INDICATES EQUIPMENT MARKING.
6. SWITCH POSITIONS REQUIRED FOR VARIOUS RADIOS IN THE RADIO RELAY NET, AS SHOWN IN TABLE.

TERMINAL RADIO		RADIO RELAY SITE				TERMINAL RADIO	
RADIO SET NO. 1		RADIO SET NO. 2		RADIO SET NO. 3		RADIO SET NO. 4	
RADIO	SWITCH	RADIO	SWITCH	RADIO	SWITCH	RADIO	SWITCH
RT-505/ PRC-25 OR RT-841/ PRC-77	FUNCTION: SQUELCH	RT-505/ PRC-25	FUNCTION: RETRANS.	RT-505/PRC-25 OR RT-841/PRC-77	FUNCTION: RETRANS.	RT-505/ PRC-25 OR RT-841/ PRC-77	FUNCTION: SQUELCH
RT-246/VRC OR RT-524/VRC	SQUELCH: NEW ON, NEW OFF, OR OLD OFF			RT-246/VRC OR RT-524/VRC	SQUELCH: NEW ON	RT-246/VRC OR RT-524/VRC	SQUELCH: NEW ON, NEW OFF, OR OLD OFF
AN/ARC-54 OR AN/ARC-131	SQUELCH: TONE			RT-246/VRC OR RT-524/VRC	SQUELCH: OLD ON	AN/ARC-54 OR AN/ARC-131	SQUELCH: TONE
						COMPATIBLE FM RADIO SET OTHER THAN THOSE LISTED ABOVE.	NOT APPLICABLE

TM5820-398-12-C2-9

Figure 6-2. Radio relay connections and conditions.

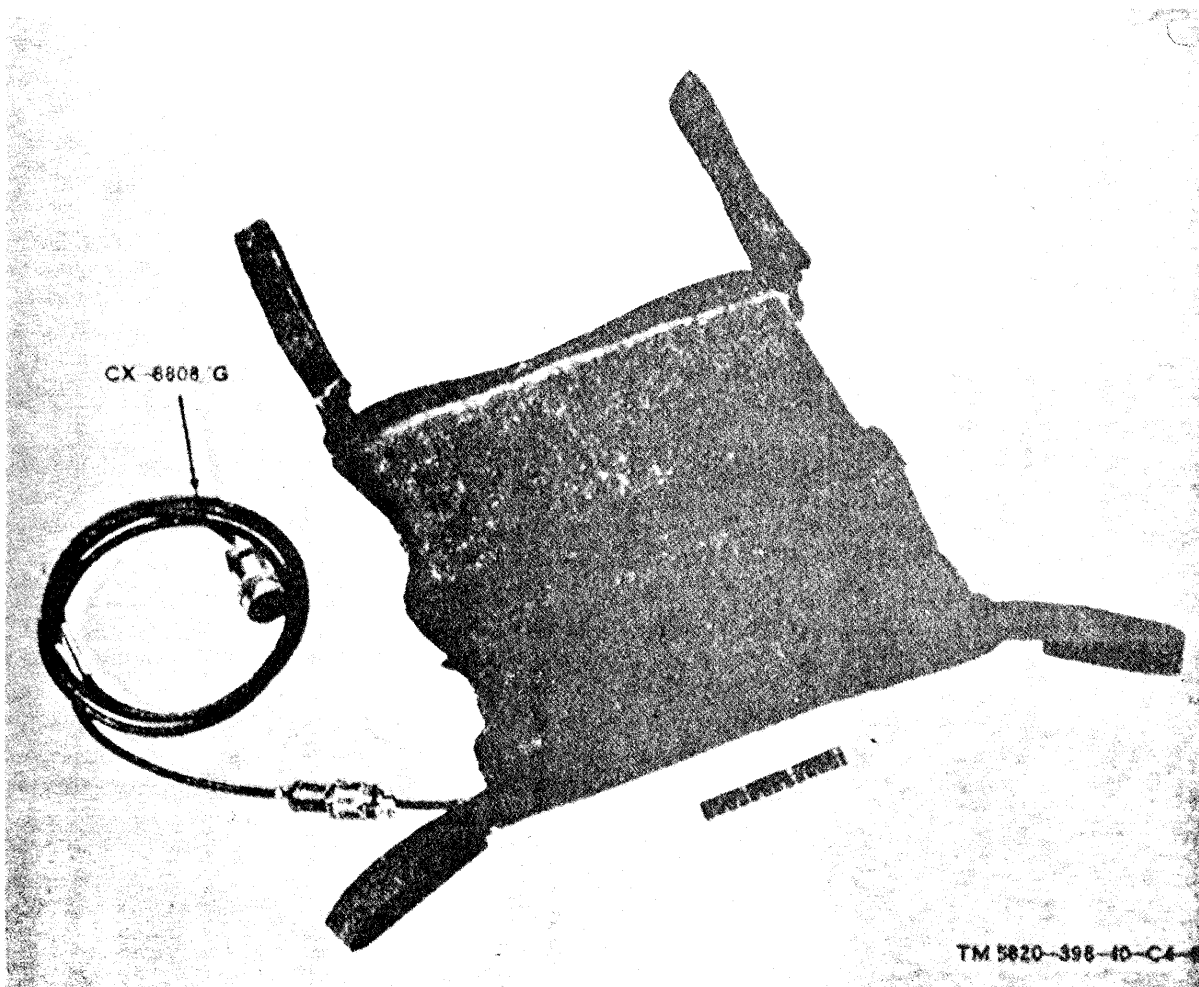

Figure 6-3. Battery, Dry BA-398/U, with Cable Assembly, Special purpose, Electrical CX-8088/G.

bly, Radio Frequency CG-2840A/U is connected to the CG-3344/PRC to extend the distance between the radio set and the AT-1082/PRC. Refer to TM 11-5985-284-15 for operating instructions with radio sets such as the AN/PRC-25.

6-5. Antenna AT-984/G, Installation and Maintenance (fig. 6-5)

Antenna AT-984A/G (FSN 5820-926-0201) is a long-wire, multiple wavelength antenna that is used to extend the normal transmission and reception range of radio sets that are pro-

vided with the RT-505/PRC-25 and RT-841/PRC-77.

a. Description. The AT-984/G consists of a canvas bag and 150 feet of antenna wire wound on a reel. The antenna wire is connected to the reel with a nylon cord (fig. 6-8). A cord at the other end of the wire is used to suspend the antenna wire during operation of the radio set. The end of the antenna wire is soldered to a terminal lug that is crimped around the wire and the insulating tubing to strengthen the connection. The canvas bag has two locking devices on the rear for attachment to the belt of the user while he is unwinding the antenna wire with the reel inside the bag.



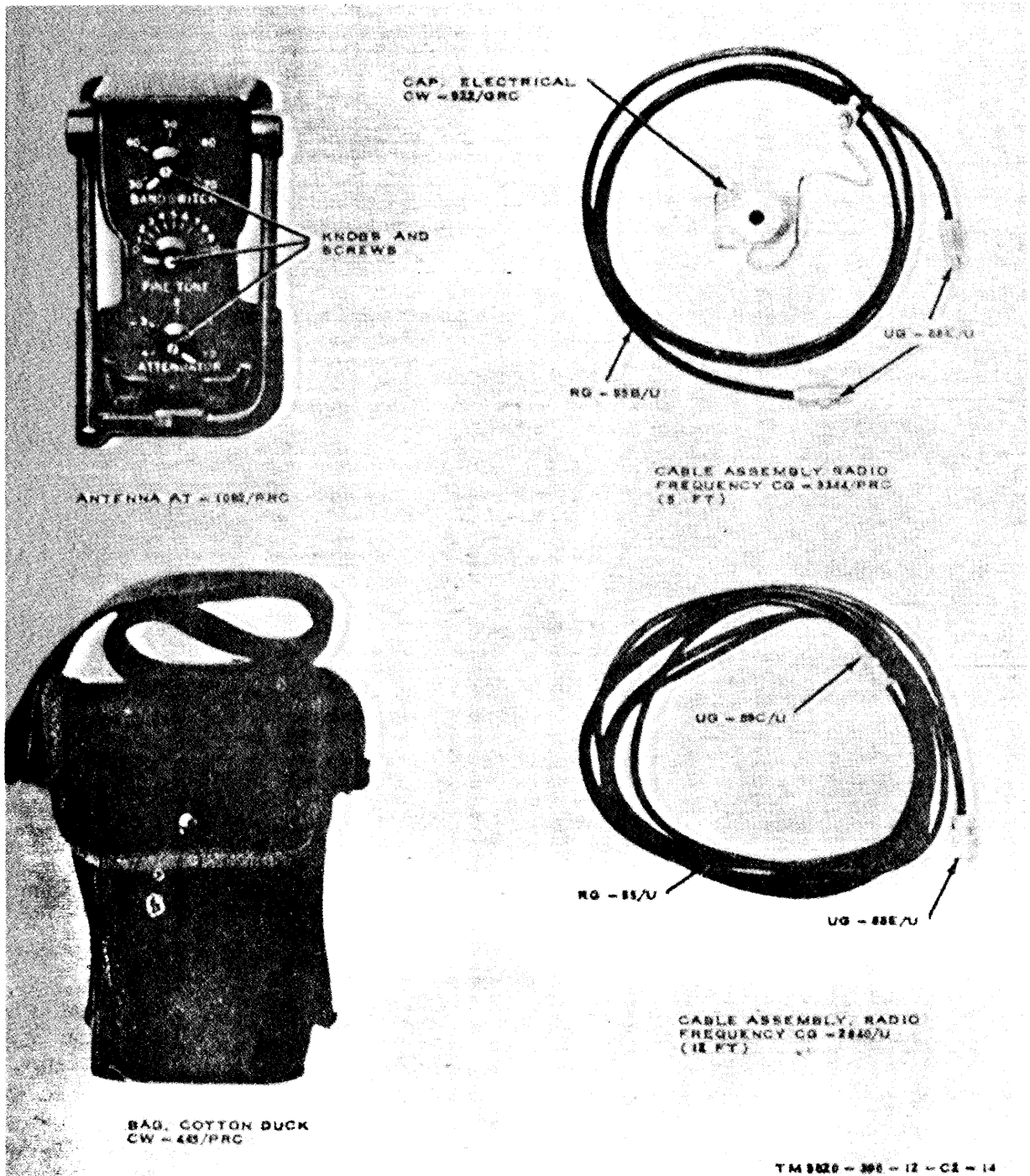

Figure 6-4. Antenna Homing Loop AT-784/PRC.

*Siting and Installation.*

(1) *Siting* (fig. 6-6). The operating range of the AN/PRC-25 and is primarily

line of sight. That is, if the location of the other radio station can be seen, transmission and reception will probably be satisfactory. An

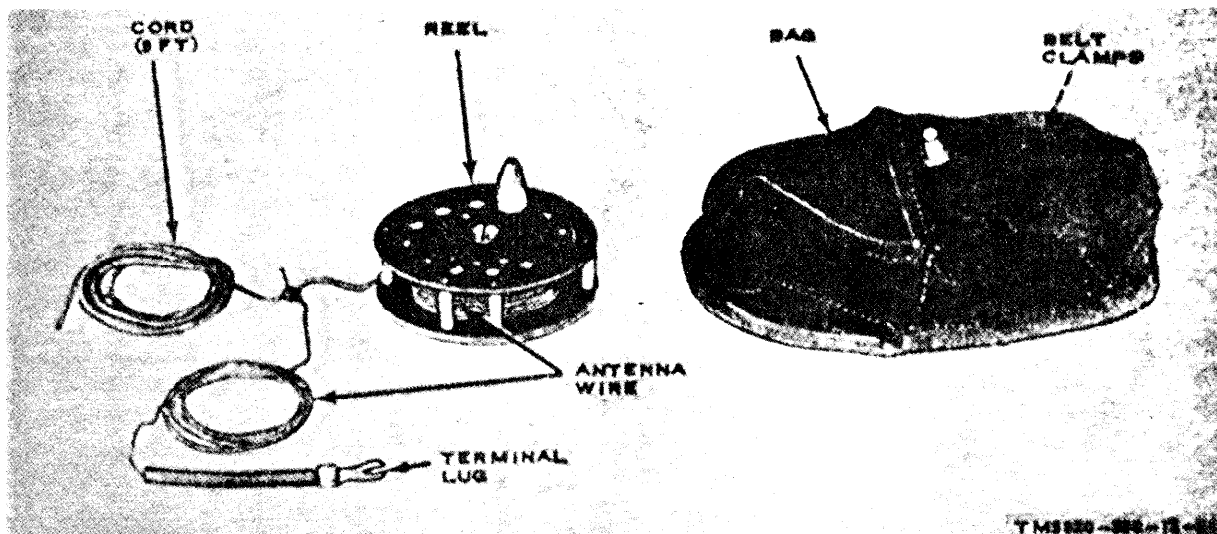

Figure 6-5. Antenna AT-984/G, components.

intervening hill or tall building may hamper or prevent contact with the other station.

(a) Avoid siting the radio set in valleys, densely wooded areas, and low places. Location on a hilltop will increase the operating range if the other station's location can be seen.

(b) Avoid siting the radio set near interference sources such as power or telephone lines, radar sets, and field hospitals.

(c) Make sure that there are no obstacles preventing the antenna wire from being extended its full length of 150 feet in a straight line toward the other station. Transmission and reception with a long-wire antenna is off the end of the antenna in the direction away from the radio set.

(2) *Installation.* The speed of the reel action can be varied by changing the position of the button on the side of the reel. With the button in one position, the reel turns slowly because the ratchet is engaged. With the button on the other position, the reel turns freely because the ratchet is not engaged.

(a) Connect the terminal lug at the end of the antenna wire to the radio set as given in 1 through 3 below. Figure 6-7 shows the connection to the RT-505/PRC-25,

1. Remove the long whip antenna

AT-271A/PRC from Support, Antenna AB-591/PRC-25.

2. Unscrew the AB-591/PRC-25 slightly, and insert the lug of the antenna wire under it.

3. Tighten the AB-591/PRC-25.

4. When the antenna is aimed toward the other radio station that is also equipped with a long-wire antenna, the area of communication covers 18° of azimuth on either side of the line along which the antenna is aimed (B, fig. 6-6). If the other station is equipped only with a whip antenna, the area of communication covers only 15° (A, fig. 6-6).

(b) Tie the cord that is attached to the antenna wire to a nearby support that is capable of supporting the antenna wire when it is stretched to the other support 150 feet away.

(c) Unreel the antenna wire by moving in the direction of the other radio station.

*Note.* The reel can be placed in the canvas bag which then can be attached to the user's trouser belt. In this way, the antenna wire can be unreeled without handling the reel.

(d) Stretch the antenna wire approximately 4 feet above the ground by securing

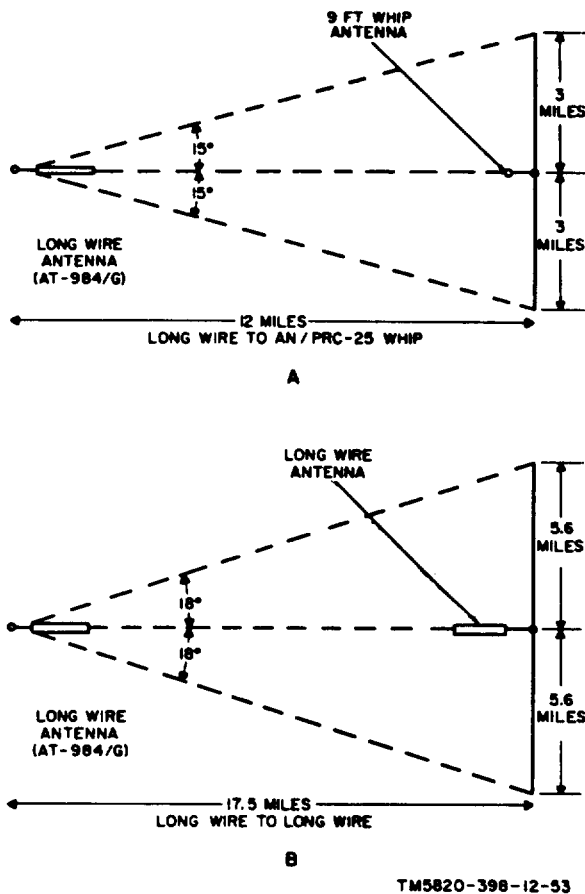

Figure 6-6. AT-984A/G, radiation patterns and siting diagram.

the reel to a building, tree, post, or similar support. Use the cord that ties the antenna wire to reel (fig. 6-8.)

**WARNING**

If the tactical situation permits, use warning signs or similar safety measures to prevent personnel and vehicles from running into the stretched antenna wire.

c. *Maintenance.* There are no maintenance parts for the AT-984A/G.

(1) If the terminal lug is broken, damaged, or lost, cut off the rubber tubing immediately behind the terminal lug (fig. 6-8), and cut back the tubing to expose 1/4 inch of antenna wire.

Obtain a new terminal lug crimp the terminal lug around the tubing in the same manner as the old terminal lug was crimped. Solder the 1/4 inch of projecting antenna wire to the terminal lug.

(2) If it is necessary to replace either of the two lengths of cord, obtain a 5-foot length of nonconductive, 10-pound test, olive-drab cord. To prevent the nylon cord from unraveling, put the end above a flame momentarily.

(3) No lubrication of the reel is required.

d. *Cleaning.* Unreel the antenna wire and clean it with a clean cloth and solvent.

**6-6. Loudspeaker, Electromagnetic LS-549/PRC**

This item is no longer available.

**6-7. Radio Set Control Group AN/GRA-39(•)**

**NOTE**

Radio Set Control Group AN/GRA-39(•) represents all models of the equipment; Control, Radio Set C-2328(•)/GRA-39 represents all models of the equipment; Control, Radio Set C-2329(•)/GRA-39 represents all models of the equipment.

The AN/GRA-39(•) may be used to provide remote radio control of radio transmission and reception of the AN/PRC-77 up to approximately 2 miles (3.3 kilometers, approximately) (a below). This equipment may also be used to provide radio/wire integration (RWI) between Switchboard, Telephone SB-22/PT (switchboard) (TM 11-5805-262-12) and the AN/PRC 77 (b below). Installation and operating instructions for the AN/GRA-39(•) are provided in TM 11-5820-477-12.

a. *Remote Radio Control.* Operation of the AN/PRC77 as described in paragraphs 3-2 through 3-8 is unchanged, except as follows:

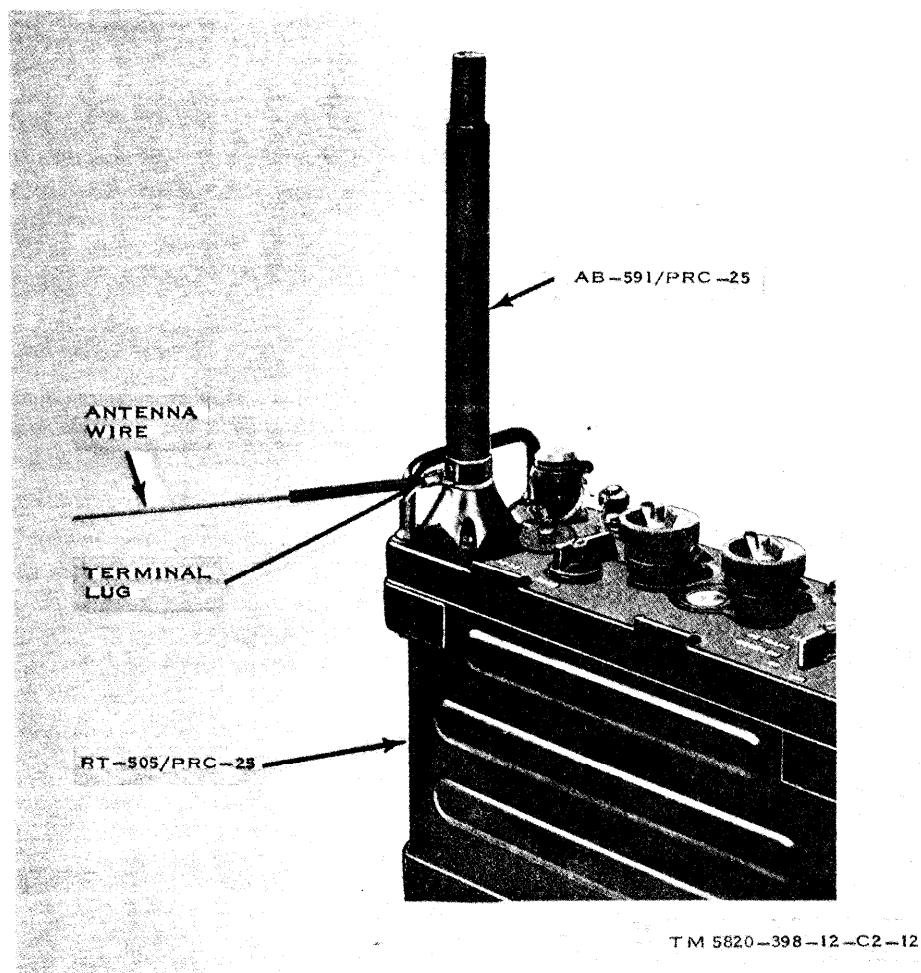

Figure 6-7. Connection of antenna wire of AT-984AIG to RT-841/PRC-77.

(1) When the AN/GRA-39 or AN/GRA-39A is used and its local control, the C-2329/GRA-39 or C-2329A/GRA-39, has not been modified by the application of MWO 11-5820-477-30/1 (re-

scinded MWD) to permit use of the function switch on the RT-841./PRC77 in the SQUELCH position, the radio communication must be conducted with the function switch

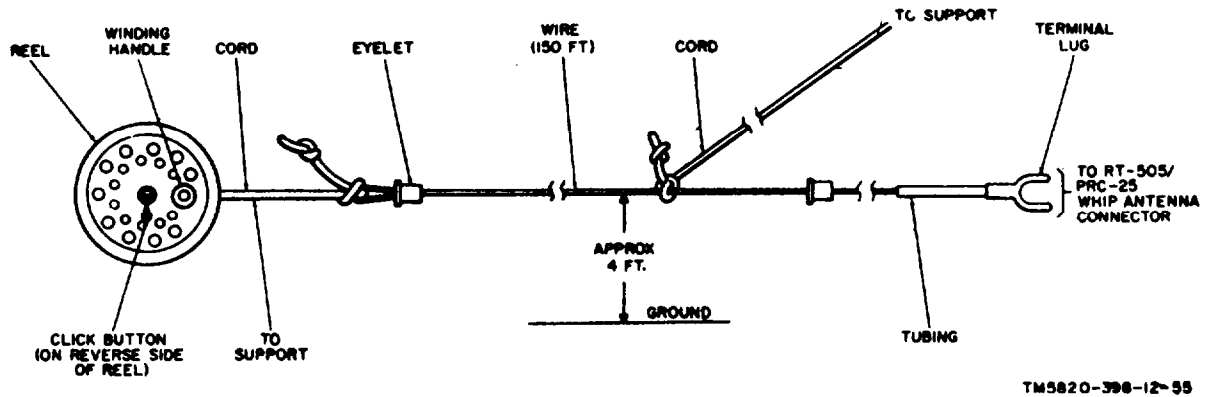

Figure 6-3. Antenna AT-984A/G, installation and parts.

set to ON only. In turn, the distant radio set in the net must also operate without squelch operation (para 3-10c(1) through (8)).

(2) When the AN/GRA-39B (in which the C-2329B/GRA-39 local control box is used) or when the local control box of the AN/GRA-39 or AN/GRA-39A ( (1) above) have been modified, the function switch of the RT-505/PRC25 may be set to SQUELCH.

(3) If the radio reception is cutting in and out (caused by receiver-to-transmitter feedback loop that causes the relay in RT-505,/PRC-25 to alternate between receive and transmit positions), set the VOLUME control on the RT-505/PRC25 down to a position at which interruption of the signal ceases.

*b. Radio/Wire Integration (RWI).* To provide RWI between the AN/PRC-25 and an SB-22/PT, using the AN/GRA-39(•), proceed as follows:

(1) *Connections.*

(a) Prepare a Connector, Plug U-182/U (FSN 5935-823-0663; part of H-138(•)/U) or U-229/U (FSN 5935-173-8537; part of H-189/GR) with two jumper wires soldered to pins A and C (keying circuit).

(b) Position the C-2328(•)/GRA-39 remote control at the SB-22/PT, and connect the equipment as shown in A, figure 8-10.

(2) *Operation.* Since the remote control is set up at the switchboard, the switchboard operator will respond to calls from the distant radio station with the push-to-talk radio position of his headset-chestset and will use correct

radio communication procedures and call signs. In effect, the switchboard operator becomes the radio operator.

(a) Set the RT-505/PRC-25 function switch and VOLUME control as given in a(1) through (9) above.

(b) Set the switches on the AN/GRA-39(•) control boxes as shown in A, figure 6-10.

(c) When the radio call sign is heard on the loudspeaker of the remote control, insert the operator's cord into the radio link jack and determine the desired subscriber. Advise the distant radio station to stand by while making the arrangements in 1 and 2 below (B, fig. 8-10) .

1. Connect the operator's cord to the subscriber's jack, ring, and notify the subscriber of the radio call. Advise the subscriber of the call signs, and tell him to ring back when the call is completed.

2. Connect the subscriber's cord to the radio link jack.

Note. Operation of the switchboard headset-chestset switch to the push-to-talk radio position while the operator's cord is connected to the subscriber's jack will key the radio.

(d) Remove the operator's cord from the subscriber's jack.

(e) The incoming radio communication can be heard on the remote control loudspeaker; the subscriber's voice cannot be heard.

(f) When the subscriber's signal indicator shows white, insert the operator's cord into the subscriber's jack and challenge the circuit without operating the headset-chestset switch to the push-to-talk position.

(g) Remove the subscriber's cord from the radio link jack.

**6-8. Radio Set Control AN/GSA-7 and Oscillator, Audio Frequency O-574/ GRA**

a. *General.*

(1) Oscillator, Audio Frequency O-574-GRA (figs. 6-11 through 6-13) produces a

*Figure 6-9. Deleted.*

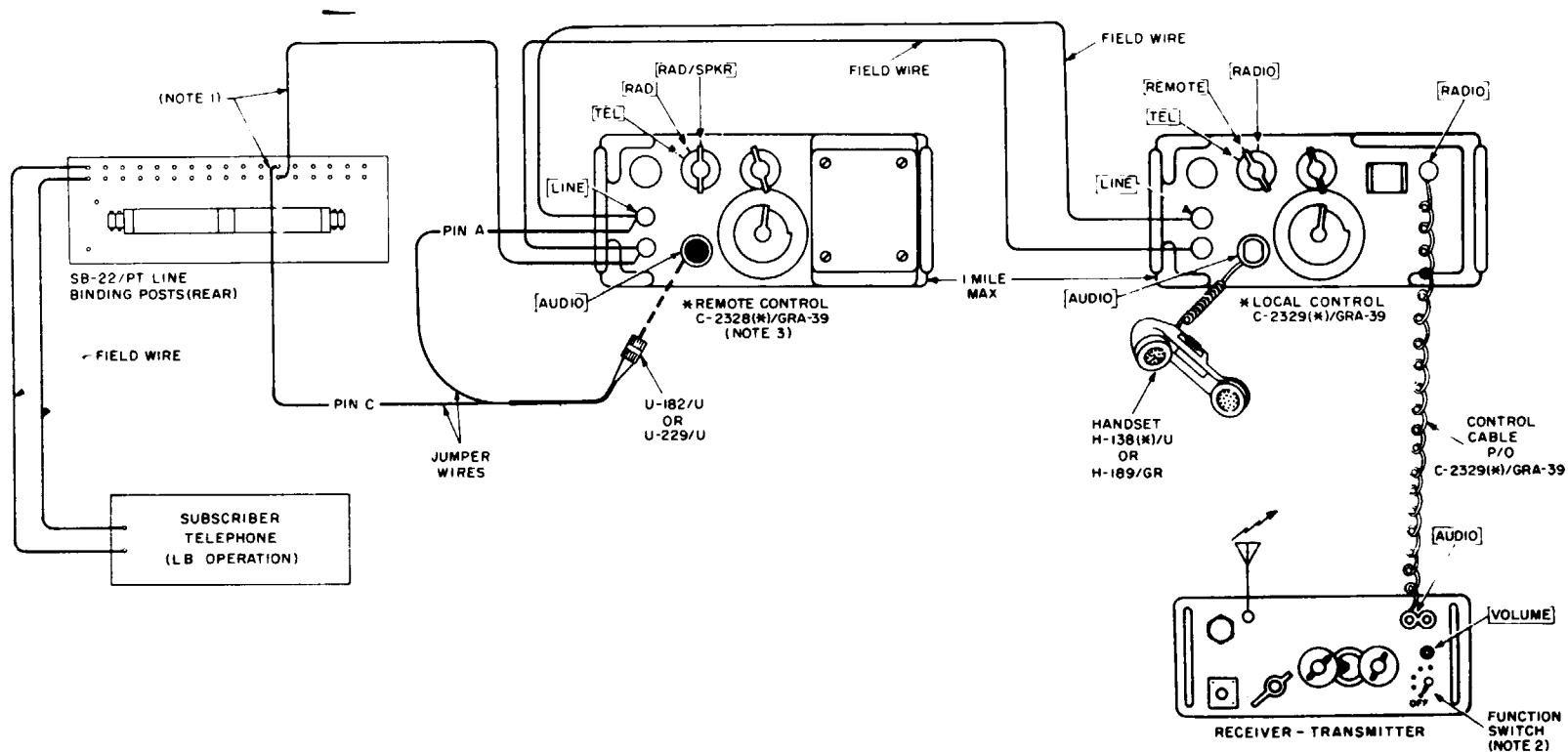

A. INTERCONNECTIONS AND SWITCH POSITIONS.

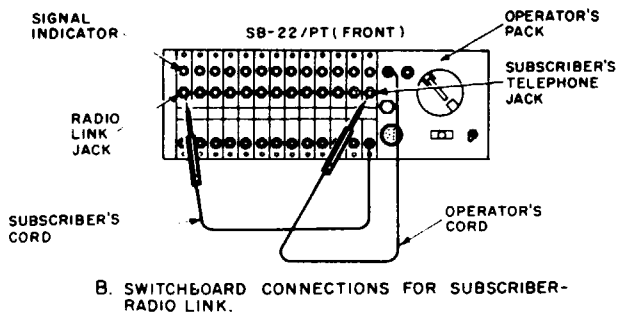

B. SWITCHBOARD CONNECTIONS FOR SUBSCRIBER-RADIO LINK.

NOTES:

- \* PART OF AN/GRA-39(\*).
- 1. IF RECEIVER-TRANSMITTER IS KEYED, TRANSPOSE CONNECTION OF THESE WIRES AT SB-22/PT.
- 2. [SQUELCH] POSITION MAY BE USED WHEN C-2329B/GRA-39 IS USED, AND WHEN C-2329/GRA-39 OR C-2329A/GRA-39 HAS MWO 11-5820-477-30/1 APPLIED.
- 3. THE REMOTE CONTROL IS LOCATED NEXT TO SB-22/PT TO ENABLE SWITCHBOARD OPERATOR TO HEAR INCOMING RADIO CALLS.

EL 5820-398-12-C3-TM-5

Change 3 6-13

Figure 6-10. AN/GRA-39(\*) in RWI with AN/PRC-25.

TM 11-5820-398-12

**TM 11-5820-398-12**

1,600-cps ringing signal for transmission through a radio system. The 0-574/GRA has two cable assemblies: Cable assembly (SC-C-75348) and Cable Assembly, Special Purpose, Electrical CX-10177/U. The cable assembly (SC-C-75348) is provided for connection between the 0-574/GRA and an audio accessory such as Handset H-33/PT; the CX-10177/U is provided for connection between the 0-574/GRA and the RT-505/PRC-25 and an audio accessory, such as Handset H-189/GR, combat vehicle crewman (CVC) helmet, etc.

**NOTE**

The 0-574/GRA may be used with

other radio sets such as the AN/VRC-12 series; the AN/PRC-77, AN/VRC-53, and Radio Sets AN/GRC-3 through AN/GRC-8, etc. The 0-574/GRA is provided to radio sets in an RWI network to enable the radio operator to ring into a switchboard which is connected to another radio set through Radio Set Control AN/GSA-7 (2) below.

(2) Radio Set Control AN/GSA-7 (TM 11-5135-115) provides RWI between Switchboard, Telephone SB-22/PT (TM 11-5805-262-12) and a radio set as far as 10 miles (16 km, approximately) distant from the radio set.

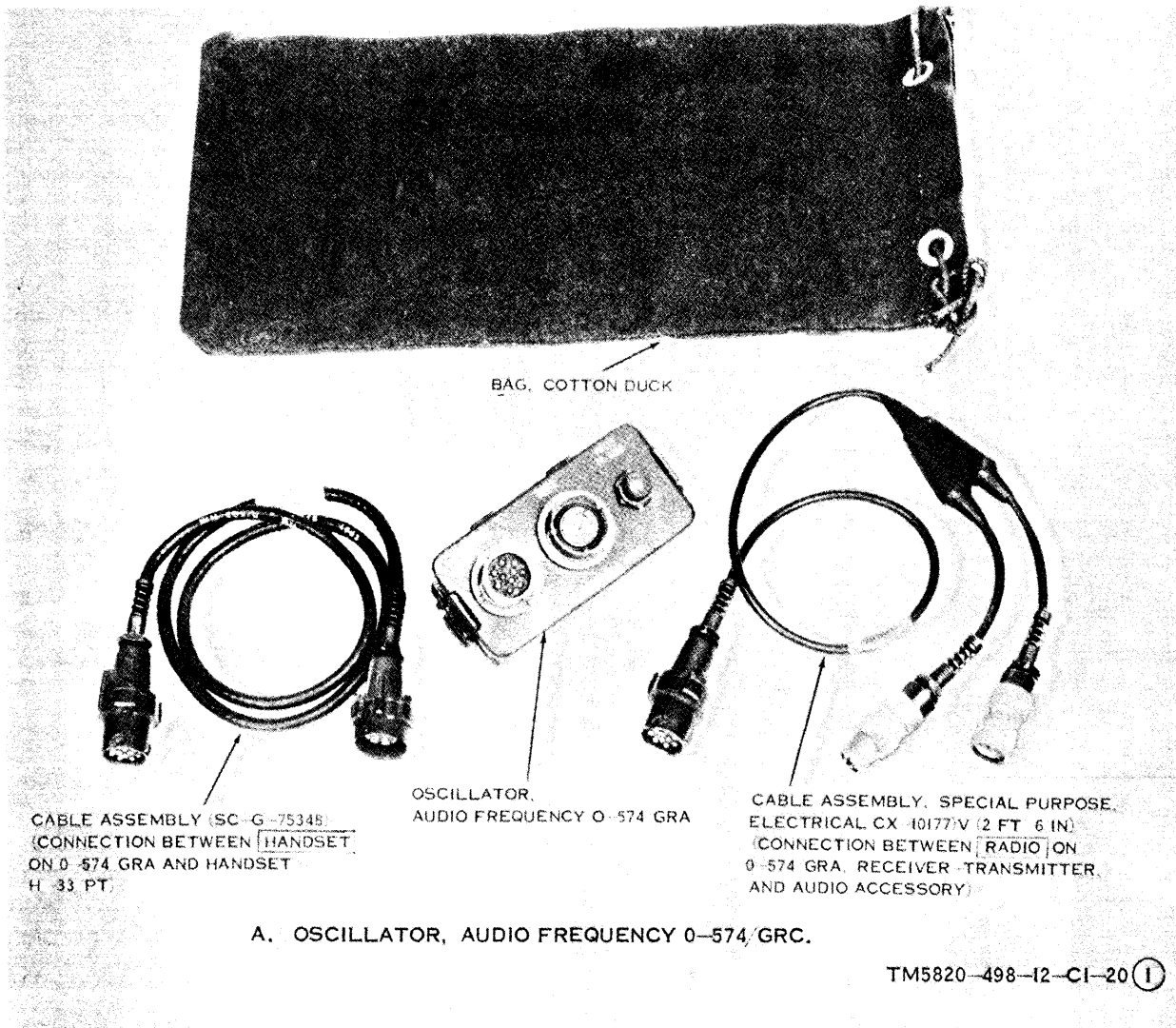
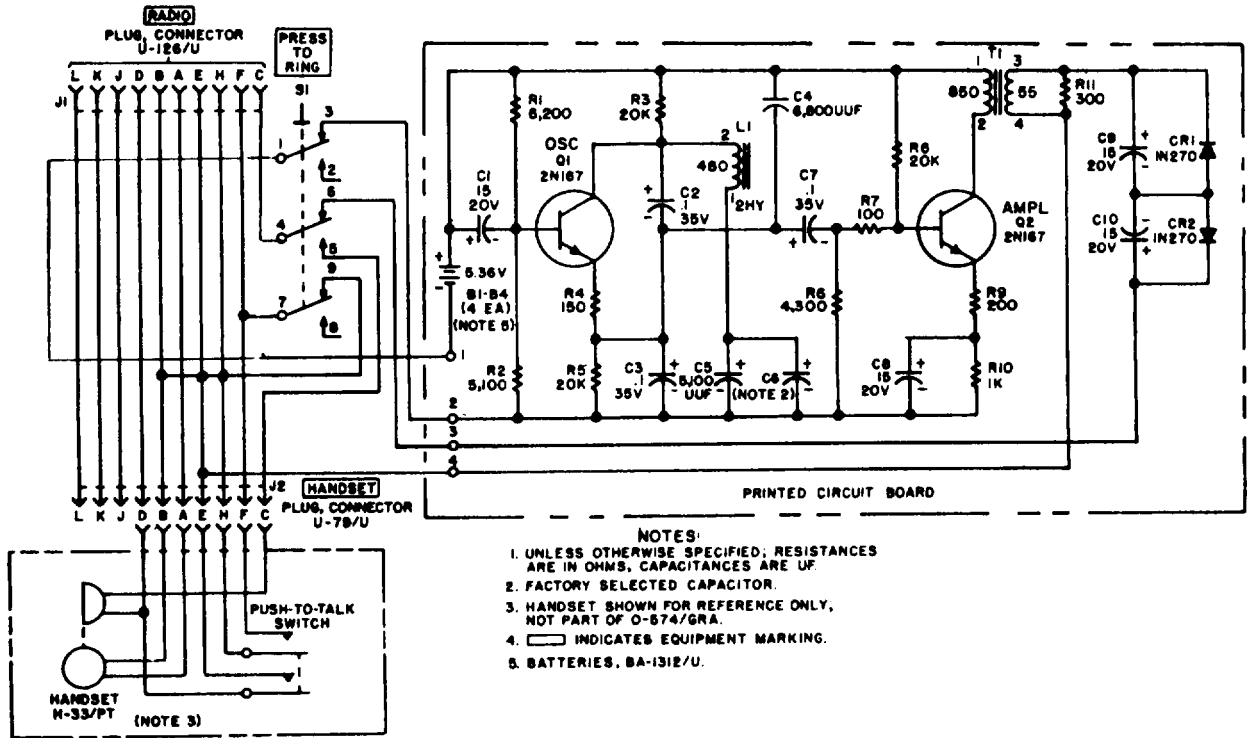
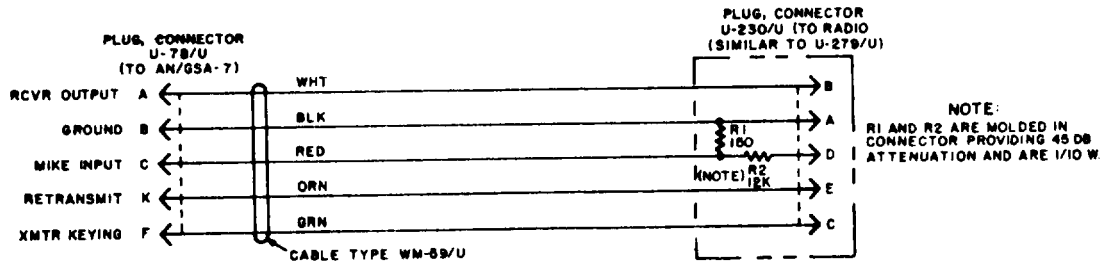

Figure 6-11. Oscillator. Audio Frequency 0-574/GRA..





A. OSCILLATOR, AUDIO O-574/GRA WITH HANDSET H-33/PT.



B. CABLE ASSEMBLY, SPECIAL PURPOSE, ELECTRICAL CX-7474/U.

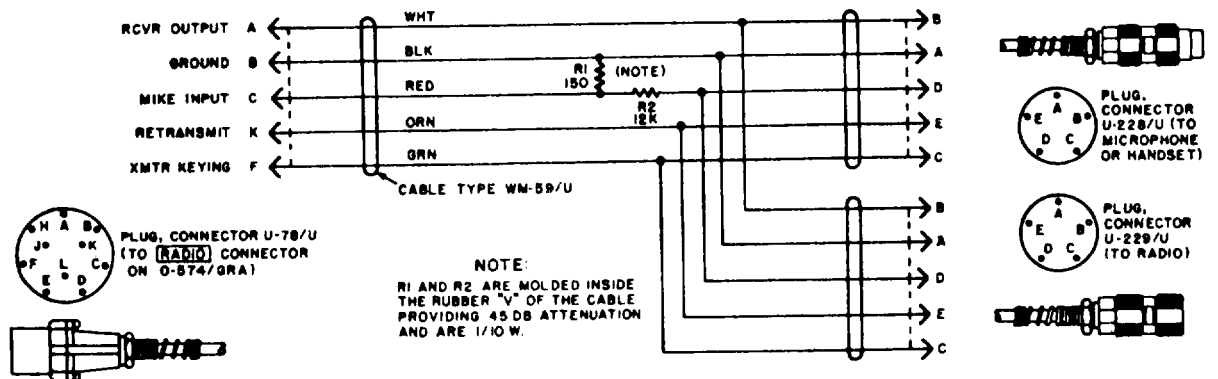

C. CABLE ASSEMBLY, SPECIAL PURPOSE ELECTRICAL CX-10177/U (2 FT, 6 IN.).

TM5820-398-12-C2-15

Figure 6-12. Oscillator, Audio frequency O-574/GRA and cable assemblies, Special Purpose, Electrical CX-7474/U and CX-10177/U, schematic diagrams.

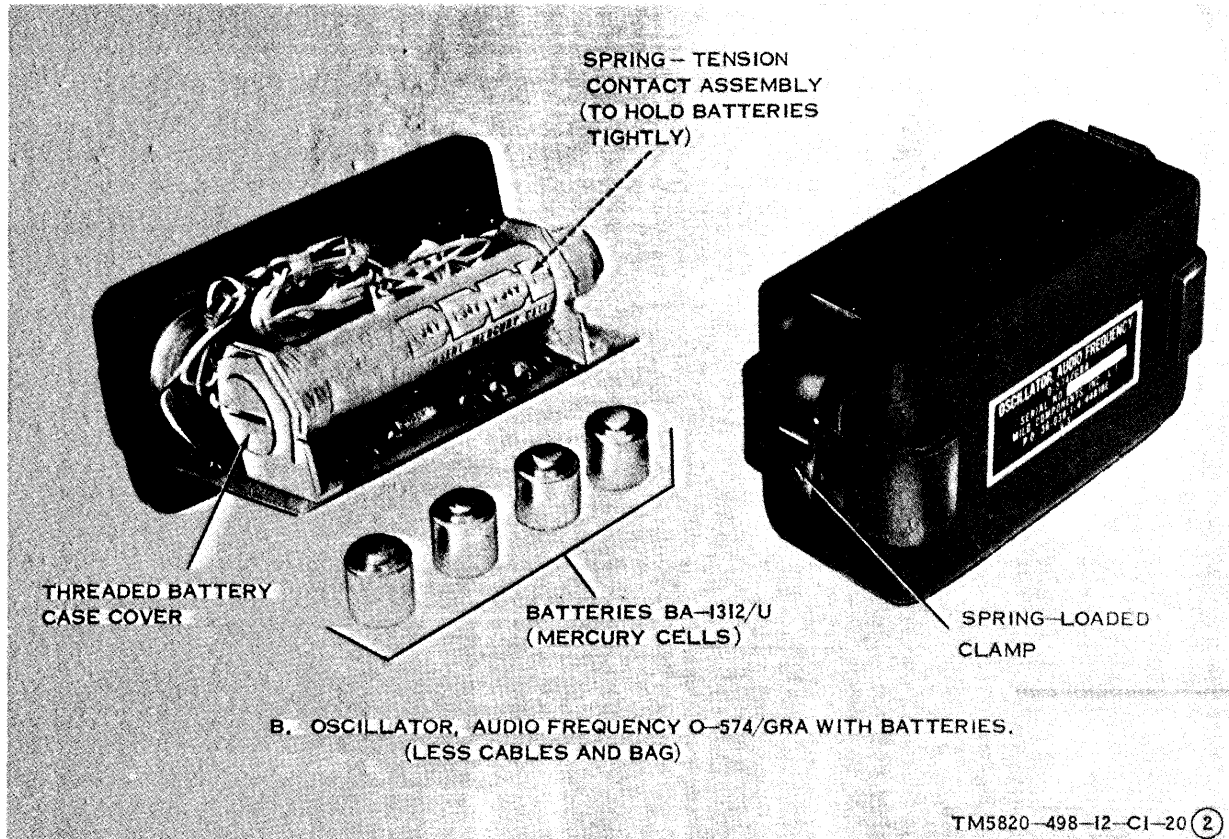

**Figure 6-13. Oscillator, Audio Frequency O-574/GRA with Batteries, Dry BA-1312/U.**

With the AN/GSA-7, there are four methods of providing RWI, depending on the number of AN/GSA-7's in the system (fig. 6-15). Cable Assembly, Special Purpose, Electrical CX-7474/U (fig. 6-14) is required for connection between the receiver-transmitter of the radio set and the AN/GSA-7.

(a) When there is an AN/GSA-7 at the other radio station (A, fig. 6-15) or the other radio station has an O-574/GRA (C, fig. 6-15), the AN/GSA-7 ringing feature (converting the switchboard 20-cps ringing signal to a 1,600-cps signal for transmission through the radio system and vice versa) can be used. For this reason, a radio operator at the AN/GSA-7 is not required as in the situations in (b) below. The operating procedures for two AN/GSA-7's in the system are given in c below. The operating procedures for AN/

GSA-7 and O-574/GRA in the system are given in d below.

(b) When there is no AN/GSA-7 at one radio station (B, D, fig. 6-15), the automatic ringing feature in the AN/GSA-7 through the radio system is no longer effective. Accordingly, either an operator is at the AN/GSA-7 to arrange with the switchboard operator for RWI (B, fig. 6-15; d(1) below) or a telephone next to the radio and connected to it through the switchboard is used by the switchboard operator to hear radio calls (D, fig. 6-15).

b. *Connections.* The following connections at the AN/GSA-7 are used whether there is a radio operator in the system (c below) or not (d below).

(1) Interconnect the AN/GSA-7 and RT-505/PRC-25 with the CX-7474/U (A,

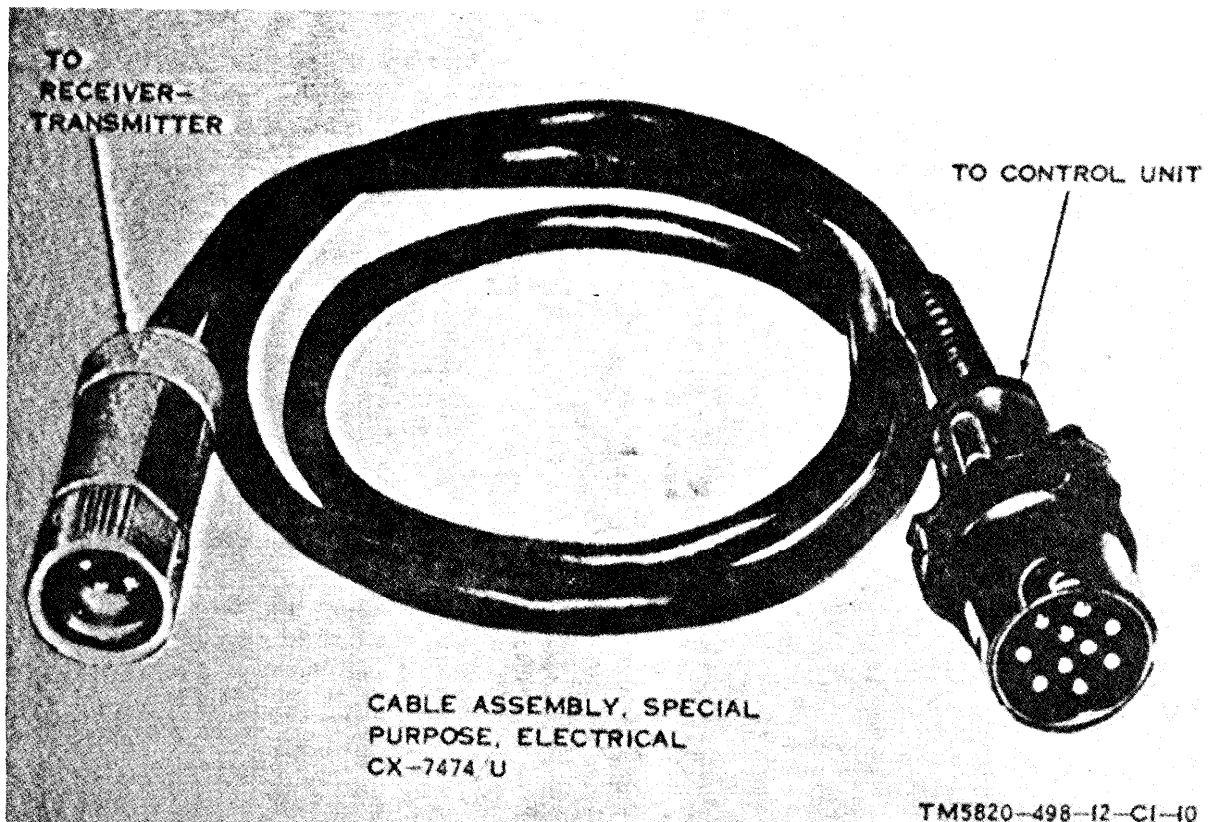

Figure 6-14. Cable Assembly, Special Purpose, Electrical CX-7474/U.

fig. 6-16). Do not connect the monitor telephone unless there is no radio operator at the AN/GSA-7 (d(2) below).

(2) Before using the 0-574/GRA, install four Batteries, Dry BA-1312/U (fig. 6-18). Unlatch the spring-loaded clamps, and remove the front panel with the chassis attached. Install the four BA-1312/U batteries as shown in the diagram on the tubular battery case. The spring-loaded contact assembly in the bottom of the battery case will cause the top battery to protrude slightly. Screw on the threaded battery case cover completely. Replace the chassis in the case and tighten the spring-loaded clamps.

(3) Set the RT-505/PRC-25 function switch to ON. Tune in a desired radio station.

(4) Make the following adjustments on the AN/GSA-7:

(a) Connect the AN/GSA-7 to a power source (TM 11-5135-15).

(b) Set the OFF-AC-DC switch to A C or DC, depending on the power source.

(c) Connect the H-33/PT to the AUDIO connector,

(d) Set the monitor switch to T RADIO&MON. The rushing noise from the RT-505/PRC-25 should be heard.

(e) Connect the field wires from the switchboard to the AN/GSA-7 LINE binding posts. If the rushing noise ceases and beeps originating in the AN/GSA-7 are heard (indicating that the RT-505/PRC-25 has been keyed), transpose the field wires at the LINE binding posts. The rushing noise should return, and the beeps from the AN/GSA-7 should cease. If this does not occur, make the following checks:

1. Check to see that no switchboard cord is connected to the radio link jack (B, C, fig. 6-16).

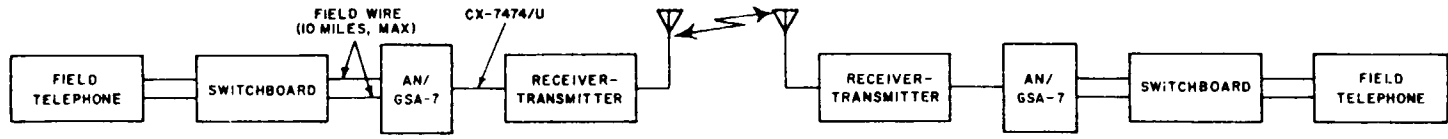

A. AN/GSA-7 AT BOTH STATIONS; RADIO OPERATOR NOT REQUIRED.

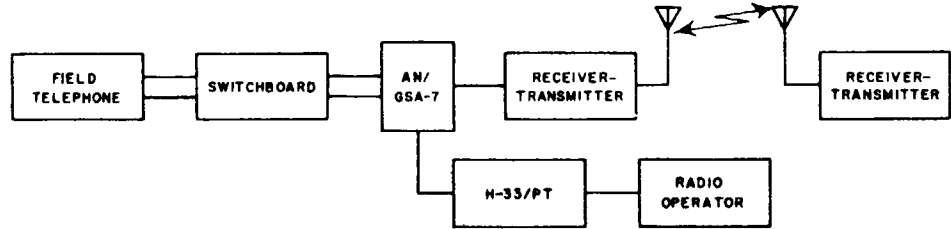

B. AN/GSA-7 AT ONE STATION; RADIO OPERATOR REQUIRED.

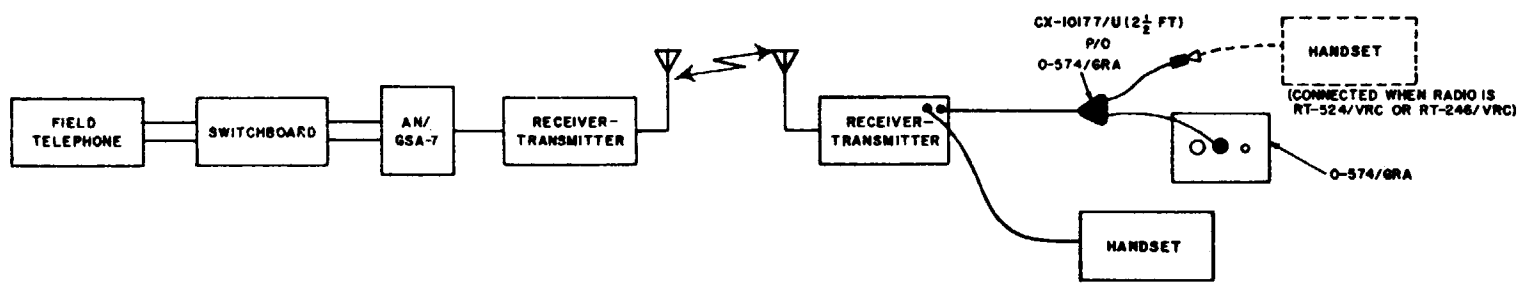

C. AN/GSA-7 AT ONE STATION, O-574/6RA AT OTHER; NO RADIO OPERATOR REQUIRED.

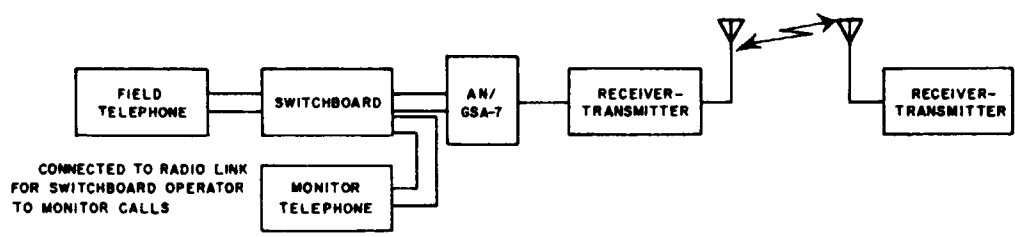

D. AN/GSA-7 AT ONE STATION, RADIO MONITOR TELEPHONE; NO RADIO OPERATOR REQUIRED.

TM5820-398-12-C2-16

Figure 6-16. Arrangements for RWI with RT-505/PRC-25 and Radio Set Control AN/GSA-7.

2. Check to see that the field wires are not short-circuited.

(f) Proceed to check the operation of the the radio with the H-33/PT.

(g) Use the procedures in c below when there are two AN/GSA-7's in the system, and those in d below when there is no other AN/GSA-7 in the system.

c. *Two AN/GSA-7's in System.* When there is an AN/GSA-7 at each radio station, no radio operator is required at the AN/GSA-7 that is connected to the RT-505/PRC-25 (A, fig. 6-15). Normal ringing between switchboard operators over the radio system can be used.

(1) Interconnect the AN/GSA-7 equipment (b above).

(2) At each AN/GSA-7, set the monitor switch to T RADIO&MON.

(8) Set the switch on each subscriber's telephone to LB operation.

(4) Switchboard and subscriber telephone operation may now proceed normally for radio operation. Use the hand generator (20 cps) to call the distant switchboard; use push-to-talk radio operation with the proper radio call signs and radio procedures.

d. *One AN/GSA-7 in System.* When there is no AN/GSA-7 at the other radio station, there are three methods of providing RW1. In one arrangement ((1) below), a radio operator is stationed at the AN/GSA-7, to make the RWI arrangements with the switchboard operator (B, fig. 6-15). In a second arrangement ((2) below), a telephone at the switchboard is continuously connected to the radio system; the switchboard operator answers radio calls on this telephone and makes RWI connections, becoming a radio operator for the operation (D, fig. 6-15). In a third arrangement ((3) below), the distant radio station operator is provided with an 0-574/GRA which will provide the 1,600-cps signal to ring through an unattended AN/GSA-7 to call the switchboard (C, fig. 6-15).

(1) *Radio operator at AN/GSA-7.* These procedures require a radio operator at the AN/GSA-7.

(a) Interconnect the AN/GSA-7 equipment (b above).

(b) At the AN/GSA-7, set the monitor switch to T RADIO&MON position. Use

the H-33/PT to communicate with the distant radio station.

(c) When RWI is required for communication with a switchboard subscriber, advise the distant radio station to stand by while the arrangements in 1 through 3 below are being made:

1. On the AN/GSA-7, hold the monitor switch at R TEL to ring the switchboard, Release the switch, and request the switchboard operator for connection with the desired subscriber.

2. At the switchboard, the operator connects the operator's cord to the desired subscriber's jack, rings, advises the subscriber of the radio call, and the call signs, and requests him to ring back when the radio communication is completed.

3. The switchboard operator then connects the subscriber's cord to the radio link jack (B, fig. 6-16) and tells the radio operator that the subscriber is ready.

(d) At the AN/GSA-7, the radio operator sets the AN/GSA-7 monitor switch to T RADIO&MON position. Communication between the subscriber and the distant radio station proceeds automatically on push-to-talk operation. The radio operator at the AN/GSA-7 can monitor the communication.

(e) At the switchboard, the operator removes the operator's cord from the subscriber's jack during the subscriber-radio communication.

(f) When the subscriber rings off (the subscriber's signal indicator will indicate white), insert the operator's cord into the subscriber's jack and challenge the circuit without operating the headset-chestset switch to the push-to-talk radio position (this would key the radio).

(g) Remove the operator's and subscriber's cords when the subscriber-radio communication is finished.

(2) *No radio operator at AN/GSA-7.* When there is no radio operator available at the AN/GSA-7, a monitor telephone is connected at the switchboard to the radio link for listening for radio calls that require RWI connections.

(a) Interconnect the AN/GSA-7 equipment (b above).

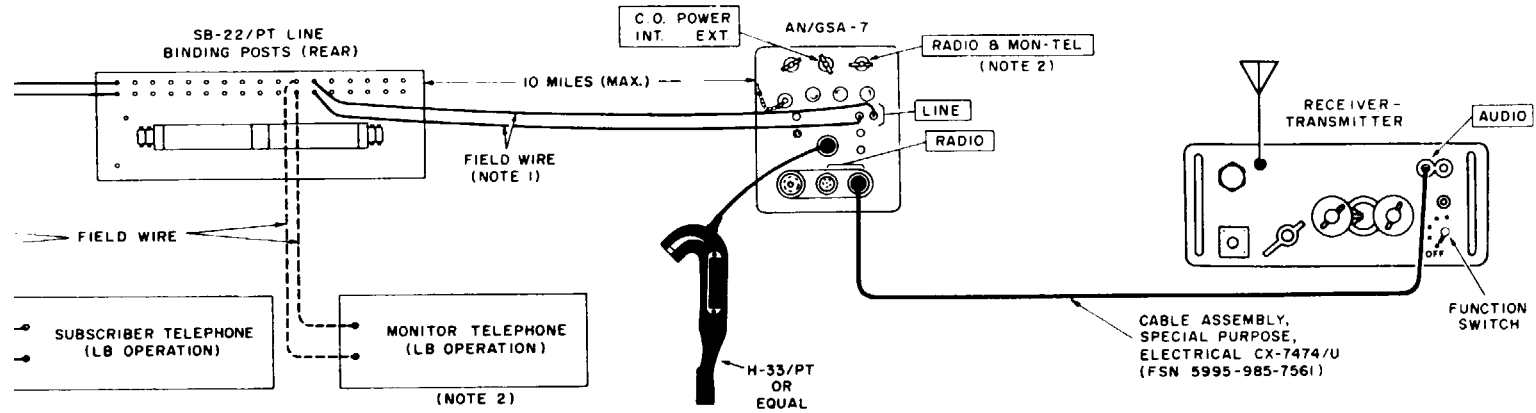

A. CONNECTIONS AND SWITCH POSITIONS.

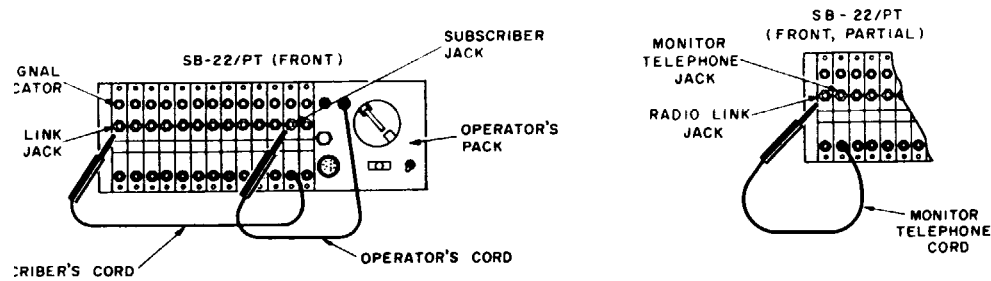

B. CORD CONNECTIONS FOR OPERATOR AND SUBSCRIBER COMMUNICATION ON RADIO LINK.

C. CORD CONNECTION FOR MONITOR TELEPHONE (NOTE 2).

NOTES:

1. IF RECEIVER-TRANSMITTER IS KEYED, TRANSPOSE THESE CONNECTIONS AT SB-22/PT.
2. THE MONITOR TELEPHONE IS LOCATED AT SB-22/PT TO ENABLE SWITCHBOARD OPERATOR TO HEAR INCOMING RADIO CALLS ON THE HANDSET WHEN THERE IS NO OPERATOR AT THE AN/GSA-7.

Figure 6-16. Radio Set Control AN/GSA-7 with RT-505/PRC-25 to provide RWI, connections and control settings.

(b) Connect a monitor telephone to the switchboard (A, fig. 6-16); set it for LB operation, and place the telephone handset so that the switchboard operator can hear radio calls. Connect the monitor telephone cord to the radio link jack (C, fig. 6-16).

(c) To communicate with the distant radio station, insert the operator's cord into the monitor telephone jack (C, fig. 6-16). Operate the switchboard handset-chestset switch to the push-to-talk radio position to key the radio and communicate with the distant radio station; use proper call signs and radio procedure.

(d) When a radio call is heard on the monitor telephone handset, use the monitor telephone to answer the call. When the desired subscriber has been determined, advise the distant radio station to stand by while the arrangements in 1 and 2 below are being made.

1. Insert the operator's cord into the subscriber's jack, ring, and advise the subscriber of the radio call and the call signs; request him to ring back when the radio communication is finished.

2. Remove the monitor telephone cord from, and connect the subscriber's cord to, the radio link jack. Communication between the subscriber and distant radio station proceeds automatically with push-to-talk radio operation.

(e) Remove the operator's cord from the subscriber's jack.

(f) When the subscriber rings off (the subscriber's signal indicator will show white), insert the operator's cord into the subscriber's jack, and challenge the circuit without operating the headset-chestset switch to the push-to-talk radio position (this would key the radio).

(g) Remove the operator's cord from the subscriber's jack, and reconnect the monitor telephone cord to the radio link jack (C, fig. 6-16) to await further radio calls.

(3) 0-574/GRA *provided at radio*. When one radio is connected to the AN/GSA-7 and another radio is provided with the 0-574/GRA-7 (C, fig. 6-15), operation can proceed as though there were two AN/GSA-7's in the system.

(a) Interconnect the AN/GSA-7 equipment (b above).

(b) Connect the 0-574/GRA to the receiver-transmitter (C, fig. 6-15).

(c) When the radio operator with the 0-574/GRA desires to call the switchboard, he presses the RING switch on the 0-574/GRA for a few seconds. The switchboard operator answers and makes the necessary connection to the subscriber.

(d) When the switchboard operator desires to call a radio operator who is provided with an 0-574/GRA, he can either ring or use the call sign on the radio link line. If the switchboard operator uses ringing to call, the 0-574/GRA user must be aware of the 1,600-cps buzz in his audio accessory, alerting him to a call from the switchboard operator.

### 6-9. Control Group AN/GRA-6

The AN/GRA-6 (TM 11-5038) may be used for remote radio control of the radio transmission and reception of the radio set at a separation of 2 miles (1.6 km, approximately) (a below). This equipment may also be used to provide RWI between Switchboard, Telephone SB-22/PT (TM 11-5805-262-12) and the radio set (b below), Cable Assembly, Special Purpose, Electrical CX-7474/U (FSN 5995-985-7561) (fig. 6-14) is required for the connection between the receiver-transmitter and Local Control C-434/GRC (A, fig. 6-17). Remote Control C-433/GRC is connected to the C-434/GRC with field wire.

#### a. Remote Radio Control.

##### (1) Connections.

(a) Install the batteries in the C-434/GRC and C-433/GRC units of the AN/GRA-6 (TM 11-5038).

(b) Place the C-434/GRC unit next to the RT-505/PRC-25, and interconnect the two units with the CX-7474/U (A, fig. 6-17).

(c) Connect a handset to the RT-505/PRC-25; it will be used by the radio operator for radio communication.

(d) Interconnect the C-434/GRC and C-433/GRC units with field wire.

(e) To check for proper connection of the field wire to the units, perform the following operations:

1. Turn on the RT-505/PRC-25 by setting the function switch to ON. A rushing noise should be heard on the handset.

2. At the C-434/GRC unit (local), set the REMOTE switch to SET 1.

*Warning:* Voltages as high as 45 volts dc are present on the field wire when the radio is keyed from the remote control unit.

3. At the C-433/GRC unit (remote), set the SELECTOR switch to fully counterclockwise (for the left-hand write-in position). Operate the handset push-to-talk switch, and check to see that the RT-505/PRC-25 has been keyed. If it has not been keyed, release the push-to-talk switch and reverse the field wire connection to the LINE binding posts of either control unit. Recheck the keying of the RT-505/PRC-25.

(2) *Telephone operation between control units.* To prevent accidental keying of the radio by the C-433/GRC unit handset, always set the REMOTE switch on the C-434/GRC unit to TEL ONLY,

(a) To ring from either the C-434/GRC or C-433/GRC, crank the handle of the ringing generator.

(b) To communicate between the two control units, proceed as follows:

1. At the C-434/GRC, set the LOCAL switch to TEL; at the C-433/GRC, set the SELECTOR switch to TEL.

2. Remove the CX-7474/U from the C-434/GRC AUDIO connector, and replace it with an H-33/PT (or equal).

3. Communicate between the two control units using the associated handsets.

(3) *Radio communication.* Check to see that the CX-7474/U is connected between the C-434/GRC and the RT-505/PRC-25 (A, fig. 3-17).

(a) To communicate on the radio at the C-434/GRC, use the handset connected to the RT-505/PRC-25 (A, fig. 6-17).

(b) To communicate on the radio from the C-433/GRC, proceed as follows:

1. At the C-434/GRC, set the REMOTE switch to SET 1.

2. At the C-433/GRC, set the SELECTOR switch fully counterclockwise ( (1) (e)3 above).

9. Operate the H-33/PT at the C-433/GRC to communicate on the radio using

push-to-talk radio operation with the proper call signs and radio procedure.

*b. RWI Operation*

(1) *Connections.*

(a) Install batteries in the C-434/GRC and C-433/GRC (TM 11-5038).

(b) Locate the C-434/GRC beside the RT-505/PRC-25 and interconnect the two units with the CX-7474/U (B, fig. 3-17).

(c) Locate the C-433/GRC beside the switchboard, and interconnect the C-434/GRC and C-433/GRC and the SB-22/PT with field wire.

(d) Position a monitor telephone next to the switchboard, and connect it to one of the line binding posts of the switchboard.

(e) To check for proper connection of the field wire, perform the following operations:

1. Turn on the RT-505/PRC-25 by setting the function switch to ON. Connect a handset to the RT-505/PRC-25; a rushing noise from the radio should be heard.

2. At the C-434/GRC, set the REMOTE switch to SET 1.

3. At the C-433/GRC, set the SELECTOR switch fully counterclockwise (for the left-hand write-in position).

4. At the C-433/GRC, connect an H-33/PT to the AUDIO connector (B, fig. 6-17); tape the push-to-talk switch of the handset so that it is always operated.

5. At the switchboard, connect the operator's cord to the radio link jack and operate the switch on the operator's headset chestset to the push-to-talk radio position to key the radio. If the radio is not keyed, release the switch and reverse the connections of the field wire to the switchboard binding posts. Recheck the keying of the radio with the switchboard operator's set.

(f) Connect the monitor telephone cord to the radio link jack (D, fig. 6-17); set it for LB operation, and place the telephone handset so that the switchboard operator can hear radio calls.

(2) *Operation.* The monitor telephone connected at the switchboard to the radio link will be used by the operator to hear incoming radio calls requiring RWI.



(a) To communicate on the radio from the RT-505/PRC-25, use the handset connected to the radio.

(b) To use the telephone circuit between the C-434/GRC and C-433/GRC, connect an H-33/PT to the C-434/GRC in place of the CX-7474/U and use the procedures given in a(2) above.

(c) For the switchboard operator to communicate on the radio, proceed as follows:

1. Connect the operator's cord to the radio link jack.

2. Use the push-to-talk radio position of the headset-chestset switch to key the radio, and release the switch to receive the radio communication.

(d) When a radio call is heard on the monitor telephone, insert the operator's cord into the monitor telephone jack. When the desired subscriber has been determined, advise the distant station to stand by while the arrangements in 1 and 2 below are being made.

1. Insert the operator's cord into the subscriber's jack, ring, and advise the subscriber of the radio call and call signs; request him to ring back when the radio communication is completed.

2. Remove the monitor telephone cord (D, fig. 6-17 ) from, and connect the subscriber's cord to, the radio link jack (C, fig. 6-17). Communication between the subscriber and distant station proceeds automatically with push-to-talk radio operation.

(e) Remove the operator's cord from the subscriber's jack.

(f) When the subscriber rings off (the subscriber's signal indicator will show white), insert the operator's cord into the subscriber's jack and challenge the circuit without operating the headset-chestset switch to push-to-talk *radio* position (this would key the radio).

(g) Remove the operator's cord from the subscriber's jack, and reconnect the monitor telephone cord to the radio link jack (1?, fig. 6-17) to await further radio calls.



CHAPTER 7

SHIPMENT AND LIMITED STORAGE AND DEMOLITION TO PREVENT ENEMY USE

**7-1. Disassembly of Equipment**

The following instructions are recommended as a guide for preparing the AN/PRC-25 for shipment and limited storage.

- a. Remove the antenna and disconnect the H-138/U.
- b. Remove Support, Antenna AB-591/PRC-25 (if used).
- c. Fold the AT-271A/PRC and wrap the H-138/U cord. Store the antennas, the AB-591/PRC-25, and the H-138/U in the compartments of Bag, Cotton Duck CW-503/PRC-25.
- d. Unclip the CW-503/PRC-25 from the ST-138/PRC-25. Remove the receiver-transmitter from the ST-138/PRC-25. Wrap the ST-138/PRC-25.
- e. Remove the BA-386/PRC-25 from CY-2562/PRC-25.
- f. Refasten the CY-2562/PRC-25 to the receiver-transmitter case.

**7-2. Repackaging for Shipment or Limited Storage**

The exact procedure for repackaging depends on the material available and the condition under which the equipment is to be shipped or stored. adapt the procedure outlined below whenever possible. Information concerning the original packaging (para 2-1) may also be helpful.

- a. *Material Requirements.* The following materials are required for packaging Radio Set AN/PRC-25. For stock numbers of materials, consult SB 38-100.

<i>Material</i>	Quantity
Cardboard carton .....	1 ea.
Waterproof paper tape .....	10 ft.
Wrapping paperboard .....	12 sq ft.
Waterproof paper .....	50 sq ft.
Filler material .....	10 sq ft.
Corrugated cardboard .....	12 sq ft.

b. *Packaging.* The items of the AN/PRC-25 are to be packaged as outlined below.

- (1) Wrap the major component completely with wrapping paperboard and secure with waterproof tape.
- (2) Group the minor components and wrap them completely with paperboard and secure with waterproof tape.
- (3) Wrap the technical manuals in waterproof paper and seal with waterproof tape.
- (4) Line the inside of the cardboard carton with waterproof paper.
- (5) Place the two paperboard-packages and technical manuals in the cardboard carton so that there will be adequate clearance on all sides of the packages.
- (6) Stuff the filler material in the spaces around the packages.
- (7) Seal the cardboard carton with waterproof tape.

c. *Packing.* Pack the cardboard in a wooden box as in the original packing. If the original box is not available, construct a new wooden box large enough to allow 1-inch clearance on all sides. Line the inside of the wooden box with waterproof paper and corrugated cardboard. Place the cardboard carton inside the box and nail the wooden box cover.



## APPENDIX A

## REFERENCES

---

DA Pam 310-4	Index of Technical Publications: Technical Manuals, Technical Bulletins, Supply Manuals (Types 7, 8, and 9), Supply Bulletins, and Lubrication Orders.
DA Pam 310-7	US Army Equipment Index of Modification Work Orders.
SB 11-6	Dry Battery Supply Data.
SB 11-131	Vehicular Radio Sets and Authorized Installations.
SB 11-573	Painting and Preservation Supplies Available for Field Use for Electronics Command Equipment.
SB 11-576	Cold Weather Batteries for Radio Sets ANIPRC6, -8, -8A, -9A, -10, -10A, -28, -25, and -77 and Cable Assemblies for Cold Weather Operation of Transmitting Set AN/PRT-4 and Receiving Set AN-PRR-9.
TB 43-0118	Field Instructions for Painting and Preserving Electronics Command Equipment Including Camouflage Pattern Painting of Electrical Equipment Shelters.
TB SIG 291	Safety Measures to be Observed When Installing and Using Whip Antennas, Field Type Masts, Towers and Antennas and Metal Poles That are Used with Communications, Radar and Direction Finder Equipment.
TM 11-5038	Control Group AN/GRA-6.
TM 11-5135-15	Radio Set Control AN/GSA-7 (NSN 5820-00-543-1397).
TM 11-5805-262-12	Operator's and Organizational Maintenance Manual: Switchboards, Telephone, Manual SB-22/PT (NSN 5805-00-257-3602) and SB-22A/PT (5805-0-715-6171).
TM 11-5820-348-15	Organizational, Direct Support, General Support, and Depot Maintenance Manual: Antenna Equipment RC-292.
TM 11-5820-398-20P	Organizational Maintenance Repair Parts and Special Tools Lists for Radio Set AN/PRC-25 (NSN 582-00-857-0759).
TM 11-5820-401-10-1	Radio Sets AN/VRC-12 (NSN 5820-00-223-7412), AN/VRC-43 (5820-00-223-7415), AN/VRC-44 (5820-00-223-7417), AN/VRC-45 (5820-00-223-7418), AN/VRC-46 (5820-00-223-7433), AN/VRC-47 (5820-00-223-7434), AN/VRC-48 (5820-00-223-7435), AN/VRC-49 (5820-00-223-7437) (Used Without an Intercom System).
TM 11-5820-401-10-2	Radio Sets AN/VRC-12 (NSN 5820-00-223-7412), AN/RC-43 (5820-00-223-7415), AN/VRC-44 (5820-00-223-7417), AN/VRC-45 (5820-00-223-7418), AN/VRC-46 (5820-00-223-7433), AN/VRC-47 (5820-00-223-7434), AN/VRC-48 (5820-00-223-7435), AN/VRG49 (5820-00-233-7437) (Used with an Intercom System).
TM 11-5820-401-12	Operator's and Organizational Maintenance Manual Including Repair Parts and Special Tools Lists: Radio Sets AN/VRC-12 (5820-00-223-7412), AN/VRC-43 (5820-00-223-7415), AN/VRC-44 (5820-00-223-7417), AN/VRC-45 (5820-00-223-7418), AN/VRC-46 (5820-00-223-7433), AN/VRC-47 (5820-00-223-7434), AN/VRG48 (5820-

**TM 11-5820-398-2**

- 00-223-7435), AN/VRG-49 (5820-00-223-7437), AN/VRC-54 (5820-00-223-7567), and AN/VRC-55 (5820-00-402-2265); Mounting MT-1029/VRC (5820-00-893-1323) and MT-1898/VRC (5820-00-893-1324); Antenna AT-912/VRC (5820-00-897-6357); Control, Frequency Selector C-2742/VRC (5820-00-892-3343) and Control, Radio Set C-2299/VRC (5820-00-892-3340).
- TM 11-5820-477-12 Operator's and Organizational Maintenance Manual: Radio Set Control Groups AN/GRA-39 (NSN 5820-00-8894860); AN/GRA-39A (5820-00-949-9909); and AN/GRA-39B (5820-00-949-9909).
- TM 11-5820-498-12 Operator's and Organizational Maintenance Manual: Radio Sets AN/VRC-53 (NSN 5820-00-223-7467), AN/VRG-64 (5820-00-223-7475), AN/GRC-125 (5820-00-223-7411), and AN/GRC-160 (5820-00-223-7473), and Amplifier-Power Supply Groups OA-3633/GRC and OA-3633A/GRC (5820-00-973-3333).
- TM 11-5985-284-15 Operator's, Organizational, Direct Support, General Support, and Depot Maintenance Manual: Antenna, Loop AT-784/PRC (NSN 5820-00-086-7651).
- TM 11-6625-203-12 Operator and Organizational Maintenance: Multimeter AN/URM-105 and AN/URM-105C Including Multimeter ME77/U and ME77C/U.
- TM 11-6625-1686-15 Operator, Organizational, Direct Support, General Support, and Depot Maintenance Manual (Including Repair Parts and Special Tool Lists): Radio Frequency Power Test Set TS-2609/U.
- TM 11-6625-2718-14&P Operator's, Organizational, Direct Support and General Support Maintenance Manual Including Repair Parts and Special Tools List: Test Set, Radio Frequency Power AN/URM-182 (NSN 6625-00-148-9371).
- TM 38-750 The Army Maintenance Management System (TAMMS).
- TM 750-244-2 Procedures for Destruction of Electronics Materiel to Prevent Enemy Use (Electronics Command).

## APPENDIX B

### COMPONENTS OF END ITEM LIST

---

#### Section 1, INTRODUCTION

##### **B-1. Scope**

This appendix lists integral components of Radio Set AN/PRC-25 to help you inventory items required for safe and efficient operation.

##### **B-2. General**

The Components of End Item List is divided into the following sections:

- a. *Section II. Integral Components of the End Item.* These items, when assembled, comprise the AN/PRC-25 and must accompany it whenever it is transferred or turned in. The illustration will help you identify these items.
- b. *Section III. Basic Issue Items.* Not used.

##### **B-3. Explanation of Columns**

a. *Illustration.* This column is divided as follows :

- (1) *Figure number.* Indicates the figure number of the illustration on which the item is shown.
- (2) *Item number.* Not used.
- b. *National Stock Number.* Indicates the Na-

tional stock number assigned to the item and which will be used for requisitioning.

c. *Part Number.* Indicates the primary number used by the manufacturer, which controls the design and characteristics of the item by means of its engineering drawings, specifications, standards, and inspection requirements to identify an item or range of items. Following the part number the federal supply code for manufacturers (FSCM) is shown in parentheses.

d. *Description.* Indicates the Federal item name and, if required, a minimum description to identify the item.

e. *Location.* Not used.

f. *Usable on Code.* Not used.

g. *Quantity Required (Qty Reqd).* This column lists the quantity of each item required for a complete major item.

h. *Quantity.* This column is left blank for use during an inventory. Under the Rcv'd column, list the quantity you actually received on your major item. The Date columns are for your use when you inventory the major item at a later date such as for shipment to another site.

SECTION II INTEGRAL COMPONENTS OF END ITEM

(1) ILLUSTRATION		(2) NATIONAL STOCK NUMBER	(3) DESCRIPTION		(4) LOCATION	(5) USABLE ON CODE	(6) QTY REQD	(7) QUANTITY	
(A) FIG NO.	(B) ITEM NO.		PART NUMBER	(FSCM)				RCVD	DATE
1-2		5820-00-857-0759	<b>RADIO SET AN/PRC-25</b>						
1-2		5820-00-242-4967	ANTENNA 271A/PRC	(80063)					
1-2		5820-00-889-3803	ANTENNA 892/PRC-25	(80063)					
1-2		5820-00-086-7148	BATTERY BOX CY-2562/PRC-25	(80063)					
1-2		5965-00-069-8886	HANDSET H-189/CR	(80063)					
1-2		5820-00-892-8094	HARNES, ELECTRICAL EQUIPMENT ST-138/PRC-25	(80063)					
1-2		5820-00-857-0934	<b>RECEIVER-TRANSMITTER, RADIO RT-505/PRC-25</b>						
1-2		5820-00-086-7149	SUPPORT, ANTENNA AB-591/PRC	(80063)					
1-2		5820-00-086-7138	BAG, COTTON DUCK CW-503/PRC-25	(80063)					



SECTION II. MAINTENANCE ALLOCATION CHART (AN/PRC-25)

MAINTENANCE ALLOCATION CHART															
GROUP NUMBER	COMPONENT ASSEMBLY NOMENCLATURE	MAINTENANCE FUNCTIONS										TOOLS AND EQUIPMENT	REMARKS		
		INSPECT	TEST	SERVICE	ADJUST	ALIGN	CALIBRATE	INSTALL	REPLACE	REPAIR	OVERHAUL			REBUILD	
	RADIO SET AN/PRC-25	0	O H F D	O	O	H									
	HANDSET H-189/GR	0							O	F H D	D				
	ANTENNA AT-271A/PRC	0							O	F					
	ANTENNA AT-892/PRC-25	0							O	H					
	BAG, COTTON DUCK CW-503/PRC-25	0							O	H					
	HARNES, ELECTRONIC EQUIPMENT ST-138/PRC-25	0		O					O	F					
	RECEIVER-TRANSMITTER, RADIO RT-505/PRC-25	0							O						
	SUPPORT, ANTENNA AB-591/PRC-25	0							O						

## SECTION III. MAINTENANCE ALLOCATION CHART (RT-505/PRC-25)

MAINTENANCE ALLOCATION CHART														
GROUP NUMBER	COMPONENT ASSEMBLY NOMENCLATURE	MAINTENANCE FUNCTIONS										TOOLS AND EQUIPMENT	REMARKS	
		INSPECT	TEST	SERVICE	ADJUST	ALIGN	CALIBRATE	INSTALL	REPLACE	REPAIR	OVERHAUL			REBUILD
	RECEIVER-TRANSMITTER, RADIO RT-505/PRC-25	C F O O F											1,2	Exterior only Exterior only All inspection Operational test only
			G F O O F										1,2,3 3 thru 14	Those tests required to determine faulty modules A1 to A25, filters, relays and tubes
			H D										3 thru 15 3 thru 21	All test Alignment of A2, A9, A20 Align C1 and C2
						F H							4,6,7,8,11,14 15 1,2	By replacement of battery box CY-2562/PRC, case assembly and knobs (band, volume and function)
										O			3 thru 14	By replacement of modules A1 through A25, Z1, FL3, K2, K3 and tube V1
										F			3 thru 21	By replacement of front panel and selector mechanism
										D			3 thru 21	Plus shop support
										D	D		3 thru 21	Plus shop support
	SYNTHESIZER MOTHER BOARD, A26									H			3 thru 15 3 thru 21	By replacement
	AUDIO AND CONTROL CHASSIS, A27									H			3 thru 15 3 thru 21	By replacement
	NETWORK, IMPEDANCE MATCHING, A28									H			3 thru 15 3 thru 21	By replacement

**MAINTENANCE ALLOCATION CHART**

GROUP NUMBER	COMPONENT ASSEMBLY NOMENCLATURE	MAINTENANCE FUNCTIONS										TOOLS AND EQUIPMENT	REMARKS			
		INSPECT	TEST	SERVICE	ADJUST	ALIGN	CALIBRATE	INSTALL	REPLACE	REPAIR	OVERHAUL			REBUILD		
	RT-505/PRC-25 (continued)															
	AMPLIFIER, POWER SUPPLY SUBASSY, A29													H D	3 thru 15 3 thru 21	By replacement
	NETWORK DECOUPLER, A30													H D	3 thru 15 3 thru 21	By replacement

TABLE I. TOOL AND TEST EQUIPMENT REQUIREMENTS

TOOL AND TEST EQUIPMENT REQUIREMENTS				
TOOLS AND EQUIPMENT	MAINTENANCE CATEGORY	NOMENCLATURE	FEDERAL STOCK NUMBER	TOOL NUMBER
		AN/PRC-25 & RT-505/PRC-25 (continued)		
1	O	TOOL KIT, ELECTRONIC EQUIPMENT TK-101/G	5180-064-5178	
2	O	TEST SET, RF POWER TS-2609/U	6625-933-8786	
3	F,H,D	<b>TEST SET- ELECTRONICS CIRCUIT PLUG-IN UNIT AN/GRM-55</b>	6625-973-2117	
4	F,H,D	COUNTER, ELECTRONIC, DIGITAL READOUT AN/USM-207	6625-911-6368	
5	F,H,D	MULTIMETER TS-352B/U	6625-242-5023	
6	F,H,D	MULTIMETER ME-26B/U	6625-542-6407	
7	F,H,D	WATTMETER AN/URM-120	6625-813-8430	
8	F,H,D	GENERATOR SIGNAL AN/URM-103	6625-868-8352	
9	F,H,D	TOOL KIT, ELECTRONIC EQUIPMENT TK-100/G	5180-605-0079	
10	F,H,D	TOOL KIT, ELECTRONIC EQUIPMENT TK-105/G	5180-610-8177	
11	F,H,D	DUMMY LOAD, ELECTRICAL DA-75/U	5985-280-3480	
12	F,H,D	<b>SPECTRUM ANALYZER TS-723/U</b>	6625-668-9418	
13	F,H,D	GENERATOR, SIGNAL AN/URM-127	6625-783-5965	
14	F,H,D	VOLTMETER ME-30A/U	6625-669-0742	
15	H,D	<b>ANALYZER ZM-3/U</b>	6625-229-1060	
16	D	OSCILLOSCOPE AN/USM-281A	6625-053-3112	
17	D	GENERATOR, SIGNAL AN/USM-44	6625-669-4031	
18	D	GENERATOR, SIGNAL AN/URM-25D	6625-649-5193	
19	D	VOLTMETER, ELECTRONIC AN/URM-145	6625-973-3986	
20	D	POWER SUPPLY, H-P 721A, PP-3514/U	6625-445-6933	
21	O,F,H,D	<b>TEST SET, BATTERY AN/PSM-13</b>	6625-868-8644	

**APPENDIX IV**

**ORGANIZATIONAL MAINTENANCE 'REPAIR PARTS**

**AND SPECIAL TOOLS LIST**

---

**Section L INTRODUCTION**

**AIV-1. Scope**

This appendix lists repair parts and special tools required for the performance of organizational maintenance of the AN/PRC-25 and RT-505/PRC-25.

**AIV-2. General**

This Repair Parts and Special Tools List is divided into the following sections:

*a. Prescribed Load Allowance (PLA-Sections II and VIZ.* A composite listing of the repair parts, special tools, test and support equipment having quantitative allowances for initial stockage at the organizational level. Section VII (RT-505/PRC425) is not applicable.

*b. Repair Parts-Sections III and VII.* A list of repair parts authorized for the performance of maintenance at the organizational level.

*c. Special Tools, Test , and Support Equipment-Sections IV and IX.* Not applicable.

*d. Index-Federal Stock Number Cross-Reference to Figure and Item Number or Reference Designation-sections V and X.* A list of Federal stock numbers in ascending numerical sequence followed by a list of reference numbers in ascending alpha-numeric sequence, cross-referenced to the illustration figure number and reference designation.

*e. Index-Reference Designation Cross-Reference to Page Number-sections VI and XI.* A list of reference designations cross-referenced to page number.

**AIV-3. Explanation of Columns**

The following provides an explanation of columns in the tabular lists:

*a. Source, Maintenance, and Recoverability Codes (SMR), Column 1:*

(1) Source code indicates the selection status and source for the listed item. Source codes are:

Code	Explanation
P	Repair parts which are stocked in or supplied from the GSA/DSA, or Army supply system and authorized for use at indicated maintenance categories.
P2	Repair parts which are procured and stocked for insurance purposes because the combat or military essentiality of the end item dictates that a minimum quantity be available in the supply system.
P9	Assigned to items which are NSA design controlled: unique repair parts, special tools, test, measuring and diagnostic equipment, which are stocked and supplied by the Army COMSEC logistic system, and which are not subject to the provisions of AR 380-41.
P10	Assigned to items which are NSA design controlled: special tools, test, measuring and diagnostic equipment for COM SEC support, which are accountable under the provisions of AR 380-41, and which are stocked and supplied by the Army COMSEC logistic system.
M	Repair parts which are not procured or stocked, but are to be manufactured in indicated maintenance levels.
A	Assemblies which are not procured or stocked as such, but are made up of two or more units. Such component units carry individual stock numbers and descriptions, are procured and stocked separately and can be

Code	<i>Explanation</i>
	assembled to form the required assembly at indicated maintenance categories.
X	Parts and assemblies which are not procured or stocked and the mortality of which normally is below that of the applicable end item or component. The failure of such part or assembly should result in retirement of the end item from the supply system.
X1	Repair parts which are not procured or stocked. The requirement for such items will be filled by use of the next higher assembly or component.
X2	Repair parts which are not stocked. The indicated maintenance category requiring such repair parts will attempt to obtain same through cannibalization. Where such repair parts are not obtainable through cannibalization, requirements will be requisitioned, with accompanying justification, through normal supply channels.
G	Major assemblies that are procured with PEMA funds for initial issue only as exchange assemblies at DSU and GSU level. These assemblies will not be stocked above DS and GS level or returned to depot supply level.

(2) Maintenance code indicates the lowest category of maintenance authorized to install the listed item. The maintenance level codes are:

<i>Code</i>	<i>Explanation</i>
C - - -	Operator/Crew
O - - -	Organizational Maintenance

(3) Recoverability code indicates whether unserviceable items should be returned for recovery or salvage. Items not coded are expendable. Recoverability codes are:

<i>code</i>	<i>Explanation</i>
R	Repair parts and assemblies that are economically repairable at DSU and GSU activities and normally are furnished by supply on an exchange basis.
S	Repair parts and assemblies which are economically repairable at DSU and GSU activities and which normally are furnished by supply on an exchange basis. When items are determined by a GSU to be uneconomically repairable, they will be evacuated to a depot for evaluation and analysis before final disposition.
T	High dollar value recoverable repair parts which are subject to special handling and are issued on an exchange basis. Such repair parts normally are repaired or overhauled at depot maintenance activities.

**AIV-2 Change 3**

Code	<i>Explanation</i>
U	Repair parts specifically selected for salvage by reclamation units because of precious metal content, critical materials, or high dollar value reusable casings or castings.

*b. Federal Stock Number, Column 2.* This column indicates the Federal stock number assigned to the item and will be used for requisitioning purposes.

*c. Description, Column 3.* This column indicates the Federal item name and any additional description of the item required. The index number has been included as part of the description to aid in the location of "same as" items. A part number or other reference number is followed by the applicable five-digit Federal supply code for manufacturers in parentheses.

*d. Unit of Measure, Column 4.* A two character alphabetic abbreviation indicating the amount or quantity of the item upon which the allowances are based, e.g., ft, ea, pr, etc.

*e. Quantity Incorporated in Unit, Column 5.* This column indicates the quantity of the item used in the AN/PRC-25 and RT-505/PRC-25.

*f. 15-Day Organizational Maintenance Allowance, Column 3 of Section II and Column 6 of Sections III, IV, VIII, and IX.*

(1) The allowance columns are divided into four subcolumns. Indicated in each subcolumn opposite the first appearance of each item is the total quantity of items authorized for the number of equipments supported. Subsequent appearances of the same item will have the letters "REF" in the allowance columns. Items authorized for use as required, but not for initial stockage, are identified with an asterisk in the allowance column.

(2) The quantitative allowances for organizational level of maintenance represents one initial prescribed load for a 15-day period for the number of equipments supported. Units and organizations authorized additional prescribed loads will multiply the number of prescribed loads authorized by the quantity of repair parts reflected in the density column applicable to the number of items supported to obtain the total quantity of repair parts authorized.

(3) organizational units providing maintenance for more than 100 of these equipments shall determine the total quantity of parts required by converting the equipment quantity to a decimal factor by placing a decimal point before the next to last digit of the number to indicate hundredths, and multiplying the decimal factor by the parts quantity authorized in the 51-100 allowance column. Example, authorized allowance for 51-100 equipments is 40; for 150 equipments multiply 40 by 1.50 or 60 parts required.

(4) Subsequent changes to allowances will be limited as follows: No change in the range of items is authorized. If additional items are considered necessary, recommendation should be forwarded to Commanding General, U. S. Army Electronics Command, ATTN: AMSEL-ME-NMP-EM, Fort Monmouth, N. J. 07703, for exception or revision to the allowance list. Revisions to the range of items authorized will be made by the USA ECOM National Maintenance Point based upon engineering experience, demand data, or TAERS information.

*g. Illustration, Column 7.* This column is divided as follows:

(1) *Figure number, column 7a.* Indicates the figure number of the illustration in which the item is shown.

(2) *Item number or reference designation, column 7b.* Indicates the callout number or reference designation used to identify the item in the illustration.

#### **AIV-4. Special Information**

Repair parts mortality is computed from failure rates derived from experience factors with the individual parts in a variety of equipments. Variations in the specific application and periods of use of electronics equipment, the fragility of electronic piece parts, plus intangible material and quality factors intrinsic to the manufacture of electronic parts, do not permit mortality to be based on hours of end item use. However, long periods of continuous use under adverse conditions are likely to increase repair parts mortality.

#### **AIV-5. Location of Repair Parts**

*a.* This appendix contains two cross-reference indexes for each equipment (sec V, VI, X, and XI) to be used to locate a repair parts when either the Federal stock number, reference number (manufacturer's part number), or reference designation is known. The first column in each index is prepared in numerical and/or alphanumeric sequence in ascending order. Where a Federal stock number is not listed, refer to the reference numbers (manufacturer's part numbers) immediately following the Federal stock number.

*b.* When the Federal stock number is known, follow the procedures given in (1) and (2) below:

(1) Refer to the indexes of Federal stock numbers (sec V and X) and locate the Federal stock number. The FSN is cross-referenced to the applicable figure and item or reference designation.

(2) When the reference designation is determined, refer to the reference designation indexes (sec VI and XI). The reference designations are listed in numeric-alpha ascending order and are cross referenced to the page number on which they appear in the repair parts lists (see III and VIII). Refer to the page number noted in the indexes and locate the reference designation (col. 7b). If the word "REF" appears in the allowance column for the repair part, note the Federal stock number (col. 2) or manufacturer's part number (col. 3). Refer to the FSN index and note the reference designation for that FSN or part number. Refer to the reference designation index and note the page number given for the reference designation. Refer to the page noted in the RPSTL (see 111 and VIII) and locate the reference designation in column 7b of the repair parts lists.

*c.* When the reference designation is known, follow the procedures given in *b(2)* above.

*d.* When neither the FSN nor reference designation is known, identify the part in the illustration and follow directions given in *c* above or scrutinize column 3 of the repair parts list.

**TM 11-5820-398-12**

**AIV-6. Federal Supply Code for  
Manufacturers**

Code                      *Manufacturer's Name*  
80063 -----hay Electronics Command

Code                      Manufacturer's name  
81349- - - - - - - - - -Military Specifications  
96906- - - - - - - - - -Military Standards

**Change 3 AIV-2.2**



**APPENDIX E**  
**ADDITIONAL AUTHORIZATION LIST**

---

**Section L INTRODUCTION**

**1. Scope**

This appendix lists additional items you are authorized for the support of Radio Set AN/PRC-25.

**2. General**

*a.* This list identifies items that do not have to accompany the AN/PRC-25 and that do not have to be turned in with it. These items are all authorized to you by CTA, MTOE, TDA, or JTA.

*b.* Battery, Dry BA-4386/U is authorized for use with the AN/PRC- in accordance with SB 11-6.

*c.* Battery, Dry BA-398/U is authorized for arctic (extreme cold) operation. See SB-576 for authorization and other details.

**3. Explanation of Listing**

National stock numbers, descriptions, and quantities are provided to help you identify and request the additional items you require to support this equipment.

SECTION II, ADDITIONAL AUTHORIZATION LIST

(1) NATIONAL STOCK NUMBER	(2) DESCRIPTION  PART NUMBER AND FSCM	(3) U/M	(4) QTY AUTH
6135-00-926-8322 175-00-926-3503	BATTERY, DRY BA-4386/U (80058) BATTERY, DRY BA-398/U (80058) ARCTIC USE)	EA	1

**APPENDIX F**  
**EXPENDABLE SUPPLIES AND MATERIALS LIST**

---

**Section 1. INTRODUCTION**

**1. Scope**

This appendix lists expendable supplies and materials you will need to operate and maintain Radio Set AN/PRC-25. These items are authorized to you by CTA 50-970, Expendable Items (Except Medical, Class V, Repair Parts, and Heraldic Items ).

**2. Explanation of Columns**

*a. Column 1—Item number.* This number is assigned to the entry in the listing and is referenced in the narrative instructions to identify the material (e.g., “Use cleaning compound, item 5, app D”).

*b. Column 2—Level.* This column identifies the lowest level of maintenance that requires the listed item.

C-Operator/Crew

O-Organizational Maintenance

*c. Column 5—National Stock Number.* This is the National stock number assigned to the item; use it to request or requisition the item.

*d. Column 4—Description.* Indicates the Federal Item name and, if required, a description to identify the item. The last line for each item indicates the part number followed by the Federal Supply Code for Manufacturer (FSCM) in parentheses, if applicable.

*e. Column 6—Unit of Measure (U/M).* Indicates the measure used in performing the actual maintenance function. This measure is expressed by a two character alphabetical abbreviation (e.g., ea, in, pr). If the unit of measure differs from the unit of issue, requisition the lowest unit of issue that will satisfy your requirements.

SECTION II EXPENDABLE SUPPLIES AND MATERIALS LIST

(1) ITEM NO.	(2) LEVEL	(3) NATIONAL STOCK NUMBER	(4) DESCRIPTION	(5) UNIT OF MEAS
1	c	6850- 00- 105-3084	PART NO. AND(FSCM) TRICHLOROTRIFLUOROETHANE TF (81348)	OZ
2	0	6850-00-880-7616	SILICONE COMPOUND MIL-8-8660 (81349)	OZ
3	0	9150-00-110-0918	GRA PHITE GREASE, NON-SEIZING COMPOUND (81348) VV6-671	LB
4	0	8040-00-847-6387	EPOXY	OZ

SECTION VIII REPAIR PARTS FOR ORGANIZATIONAL MAINTENANCE RT-505/PRC-25

(1) SMR CODE	(2) FEDERAL STOCK NUMBER	(3) DESCRIPTION  Reference Number & Mfr Code	(4) UNIT OF MEAS	(5) QTY INC IN UNIT	(6) 15-DAY ORGANIZATIONAL MAINTENANCE ALW				(7) ILLUSTRATIONS	
					(a) 1-5	(b) 6-20	(c) 21-50	(d) 51-100	(a) FIG NO.	(b) ITEM NO. OR REFERENCE DESIGNATION
	5820-857-0934	RECEIVER-TRANSMITTER, RADIO RT-505/PRC-25 (This item is nonexpendable)							1-2	1
P-O-R	5820-086-7148	BATTERY BOX CY-2562/PRC-25	EA	1	*	*	*	*	5-1	1A31
P-O-R	5820-973-1731	CASE ASSEMBLY: SM-D-447351 (80063)	EA	1	*	*	*	*	5-1	1MP2
P-O	5820-973-1733	COVER, ELECTRICAL CONNECTOR: SM-B-447439 (80063)	EA	1	*	*	*	*	5-1	1A30MP1
P-O	5820-973-1732	COVER, ELECTRICAL CONNECTOR: SM-B-447440 (80063)	EA	1	*	*	*	*	5-1	1A30MP2
P-O	5935-978-4357	COVER, ELECTRICAL CONNECTOR: SM-C-447403 (80063)	EA	1	*	*	*	*	5-1	1A30MP3
P-O	5935-973-1859	DUMMY, CONNECTOR: SM-C-447929 (80063)	EA	1	*	*	*	*	5-1	1A30Z1
P-O	5355-951-5165	KNOB ASSEMBLY: SM-C-447306 (80063)	EA	2	*	*	*	*		1A30MP11
P-O	5355-951-5165	KNOB ASSEMBLY: SM-C-447306 (80063)	EA	REF	REF	REF	REF	REF		1A30MP12
P-O	5355-889-3425	KNOB: SM-C-447226 (80063)	EA	1	*	*	*	*	5-1	1A30MP8
P-O	5355-889-3424	KNOB: SM-C-447052 (80063)	EA	1	*	*	*	*	5-1	1A30MP7
P-O	5355-930-0728	KNOB: SM-C-447976-1 (80063)	EA	1	*	*	*	*		1A30MP9
P-O	5355-552-0451	KNOB: MS-91524-1 (81349)	EA	1	*	*	*	*	5-1	1A30MP6
P-O	5355-930-0729	KNOB: SM-C-447976-2 (80063)	EA	1	*	*	*	*		1A30MP10
X2-O	5310-973-3697	NUT, WING: SM-C-447308 (80063)	EA	2					5-1	1A30MP11H2
X2-O	5305-951-5170	SCREW, MACHINE: SM-B-447445-5 (80063)	EA	3						1A30H7

**SECTION X. INDEX-FEDERAL STOCK NUMBER CROSS REFERENCE**

**TO FIGURE AND ITEM NUMBER OR REFERENCE DESIGNATION (RTO)**

FEDERAL STOCK NUMBER	FIGURE NUMBER	ITEM NUMBER OR REF. DESIGNATION	FEDERAL STOCK NUMBER	FIGURE NUMBER	ITEM NUMBER OR REF. DESIGNATION
5305-951-5170		1A3OH7			
5310-973-3697	5-1	1A3OMP11H1			
5355-552-0451	5-1	1A3OMP6			
5355-889-3424	5-1	1A3OMP7			
5355-889-3425	5-1	1A3OMP8			
5355-930-0728		1A3OMP9			
5355-930-0729		1A3OMP10			
5355-951-5165		1A3OMP11			
5355-951-5165		1A3OMP12			
5820-086-7148	5-1	1A31			
5820-857-0934	1-2	1			
5820-973-1731	5-1	1MP2			
5820-973-1732	5-1	1A3OMP2			
5820-973-1733	5-1	1A3OMP1			
5935-973-1859	5-1	1A3OZ1			
5935-978-4357	5-1	1A3OMP3			

**SECTION XI. INDEX-REFERENCE DESIGNATION**  
**CROSS REFERENCE TO PAGE NUMBER (RT-505/PRC-25)**

<b>REFERENCE DESIGNATION</b>	<b>PAGE NUMBER</b>	<b>REFERENCE DESIGNATION</b>	<b>PAGE NUMBER</b>	<b>REFERENCE DESIGNATION</b>	<b>PAGE NUMBER</b>
1	IV-8				
1MP2	IV-8				
1A30H7	IV-8				
1A30MP1	IV-8				
1A30MP2	IV-8				
1A30MP3	IV-8				
1A30MP6	IV-8				
1A30MP7	IV-8				
1A30MP8	IV-8				
1A30MP9	IV-8				
1A30MP10	IV-8				
1A30MP11	IV-8				
1A30MP11H1	IV-8				
1A30MP12	IV-8				
1A30Z1	IV-8				
1A31	IV-8				





By Order of the. Secretary of the Army:

HAROLD K. JOHNSON,  
*General United States Army,*  
*Chief of Staff.*

Official:

J. C. LAMBERT,  
 Major General, United States Army,  
*The Adjutant General.*

Distribution:

*Active Army:*

USASA (2)	USASESOS (90)	1-75	<del>6-228</del>
CNB (1)	USAAMS (30)	1-76	<del>6-300</del>
CC-E (7)	USAARMS (30)	1-77	<del>6-302</del>
Dir of Trans (1)	USAIS (30)	1-78	<del>6-315</del>
CofEngrs (1)	USASCS (5)	1-100	<del>6-316</del>
TSG (1)	MFSS (5)	1-101	<del>6-317</del>
CofSpts (1)	USACSS (5)	1-107	<del>6-319</del>
USAIB (5)	USMA (5)	1-207	<del>6-327</del>
USACDCEA (1)	GENDEP (2)	1-307	<del>6-328</del>
USACDCCBRA (1)	Sig Sec GENDEP (5)	<del>3-267</del>	<del>6-329</del>
USACDCOA (1)	Sig Dep (12)	5-7	<del>6-345</del>
USADCQMA (1)	A DeP (2) except	5-25	<del>6-346</del>
USACDCTA (1)	SAAD (SC)	5-26	<del>6-347</del>
USACDCADA (1)	TOAD (14)	5-27	<del>6-355</del>
USACDARMA (1)	FTWOAD (10)	5-35	<del>6-356</del>
USACDCAVNA (1)	LEAD (7)	5-37	<del>6-401</del>
USAODCARYTA (1)	SHAD (8)	5-116	<del>6-415</del>
USACDCSWA (1)	NAAD (5)	5-129	<del>6-416</del>
USACDCCEA (1)	SVAD (5)	5-145	<del>6-417</del>
USACDCCEA :	CHAD (8)	5-146	<del>6-419</del>
Ft Huachuca (1)	ATAD (10)	5-147	<del>6-425</del>
USACDCEA ( 10)	LBAD (14)	5-148	<del>6-426</del>
USAMC (5)	USASTC (2)	5-155	<del>6-429</del>
USCONARC (5)	USATC AD (2)	5-156	<del>6-435</del>
ARADCOM (5)	USATC Armor (2)	5-157	<del>6-436</del>
ARADCOM <b>Rgn</b> (5)	USATC Engr (2)	5-215	<del>6-445</del>
OS Maj Comd (4)	USATC Inf (2)	5-217	<del>6-501</del>
USAMERCC (5)	USAATC (5)	<del>5-500</del>	<del>6-525</del>
LOGCOMD (2)	WRAMC (1)	(AA-	<del>6-545</del>
USAMICOM (4)	Army Pic <b>Cen</b> (2)	6-37	<del>6-555</del>
USASMC (2)	Instl (2) except	6-100	<del>6-556</del>
USASCC (4)	Ft Monmouth (70)	6-101	<del>6-557</del>
MDW (1)	Ft Hancock (4)	6-155	<del>6-558</del>
Armies (2) except	Ft Gordon (10)	6-156	<del>6-575</del>
Seventh (5)	Ft Huachuca (10)	6-157	<del>6-576</del>
Corps (2)	Pt Carraon (25)	6-165	<del>6-577</del>
USAc (8)	Ft Knox (12)	6-166	<del>6-615</del>
11th Air Aalt Div (8)	Ft Devens (5)	6-176	<del>6-617</del>
507th USASA Gp (5)	WSMR (5)	6-176	<del>6-700</del>
508th USASA Gp (5)	Sig Fid Maint Shops (2)	6-177	<del>6-701</del>
318th USASA Bn (5)	AMS (1)	6-185	<del>6-705</del>
310th USASA Bn (5)	USAERDAA (2)	6-186	<del>6-706</del>
320th USASA Bn (6)	USAERDAW (18)	<del>6-200</del>	<del>6-707</del>
177th USASA <b>Co</b> (6)	1st <b>GM Bde</b> (5)	6-201	<del>6-715</del>
182nd USASA Co (5)	USARSG (5)	6-215	<del>6-716</del>
183rd USASA Co (5)	Units organized under following	6-216	<del>6-725</del>
184th USASA Co (5)	TOE's (2 copies each) :	6-217	<del>6-726</del>
SVC Colleges (2)	1-7	1-55	<del>7</del>
Br Svc Sch (2) except	1-87	1-56	<del>7-2</del>
		6-225	
		6-226	

**TM 11-5820-398-12**

7-4	8-26	(AA-AC)	17-77	29-11	37-4
7-11	8-27	11-587	17-78	29-15	37-42
7-12	8-67	11-592	17-95	29-16	37-100
7-15	9-7	11-597	17-97	29-21	39-51
7-16	9-17	12-37	17-98	29-25	39-65
7-17	9-22	17	17-100	29-35	44-8
7-18	9-47	17-4	17-105	29-36	47
7-19	9-127	17-15	17-106	29-41	47-42
7-25	9-217	17-17	17-107	29-51	55-47
7-26	9-377	17-27	17-108	29-52	55-50
7-27	9-510	17-32	17-200	29-55	55-54
7-35	11-35	17-35	17-201	29-56	55-56
7-37	11-57	17-36	17-205	29-65	55-57
7-42	11-95	17-37	17-206	29-75	55-58
7-45	11-97	17-42	17-207	29-97	55-59
7-46	11-98	17-51	17-208	31-105	55-89
7-47	11-99	17-52	19-27	32-56	55-99
7-55	11-117	17-55	1	32-57	55-407
7-56	11-155	17-56	19-27	32-67	55-417
7-57	11-156	17-57	1 -	32-68	57
7-58	11-157	17-58	(AA-AE)	32-77	57-4
7-100	11-337	17-75	29-1	32-500	57-42
8-25	11-500	17-76	29-2	37	57-100

NG: State AG (3).

USAR : None.

For explanation of abbreviations used, see AR 320-50.

\* U. S. GOVERNMENT PRINTING OFFICE : 1993 0 - 342-421 ( 62124)

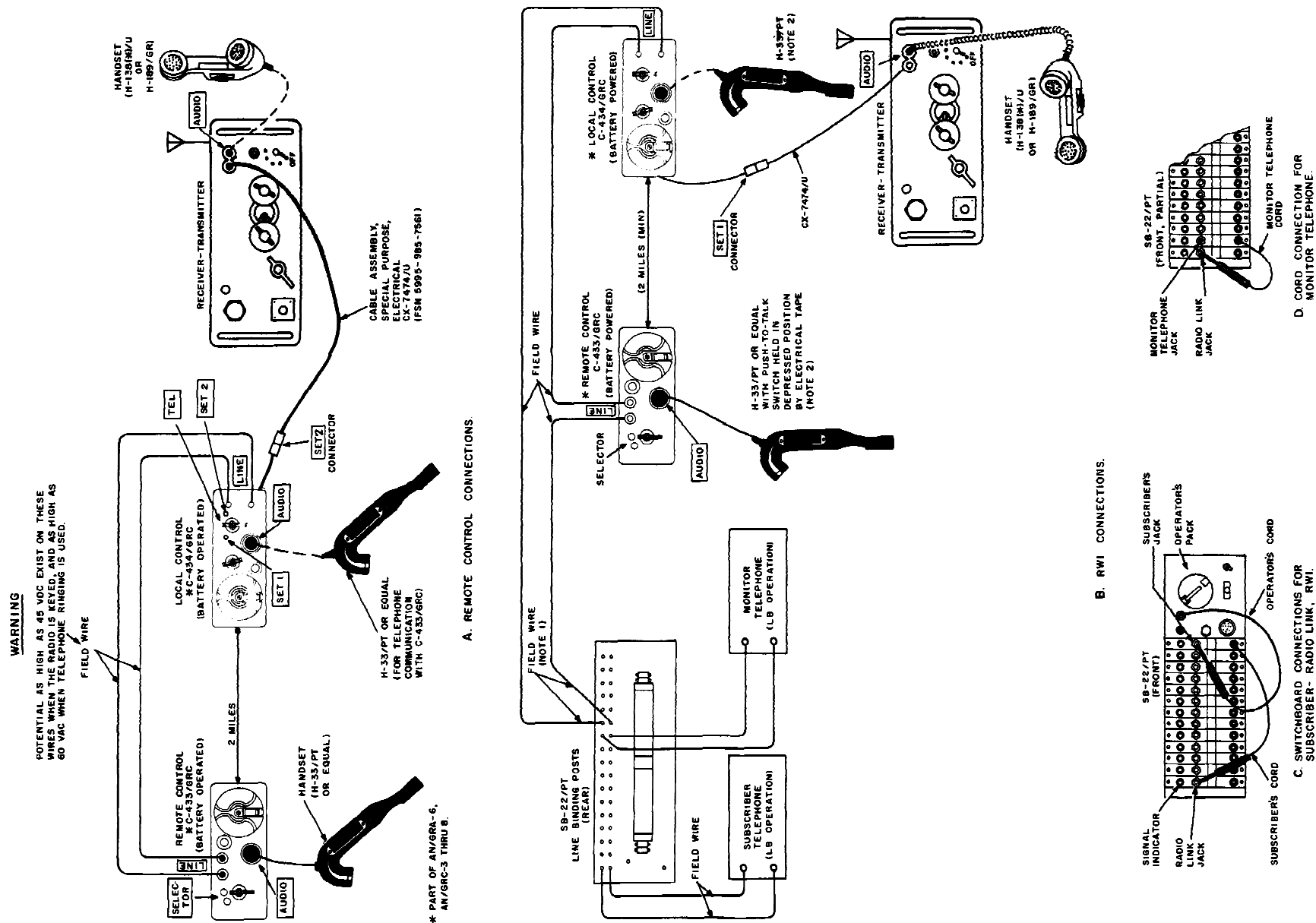
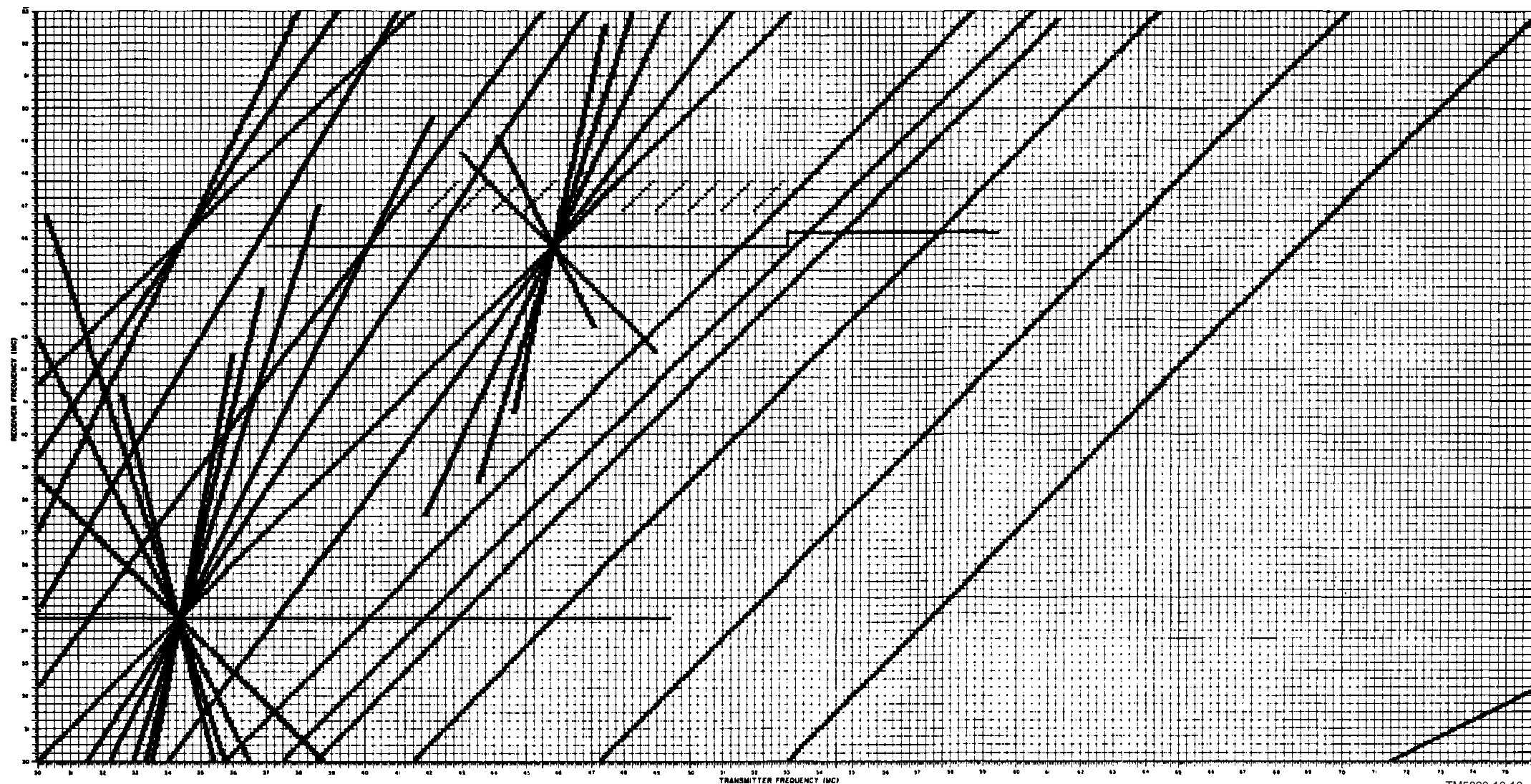

Figure 6-17. AN/GRA-6 and RT-505/PRC-25 for remote radio control and RWI; connections and control settings.

- NOTES:
1. IF RT-505/PRC-25 IS KEYS, TRANSPOSE CONNECTION OF THESE WIRES AT SB-22/PT.
  2. REQUIRED FOR TELEPHONE COMMUNICATION WITH SWITCHBOARD.
  3. \* PART OF AN/GRA-6.



TM5820-10-10

Figure 7-1 D. Retransmission interference chart (part 1 of 2).

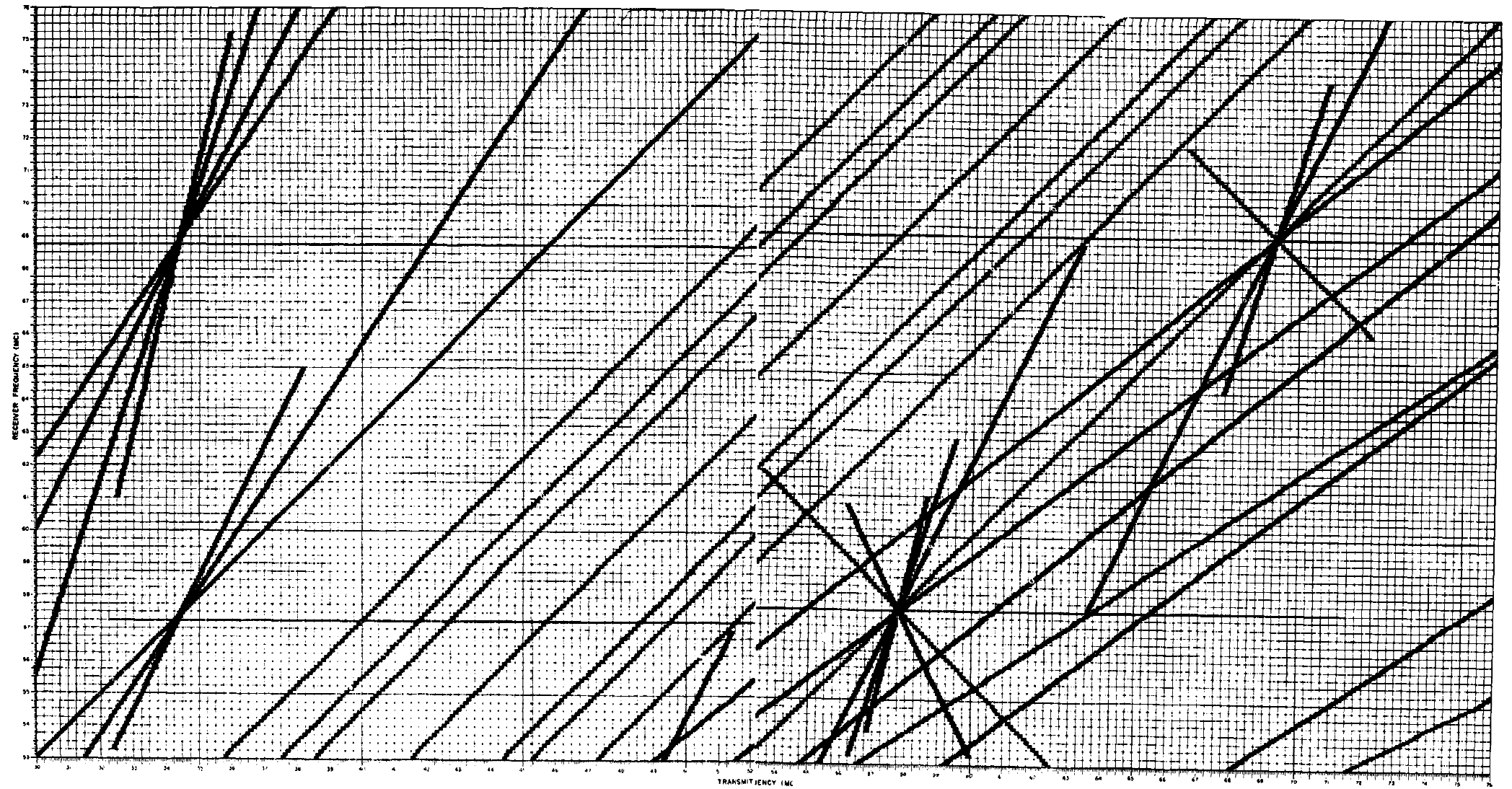

TM5820-398-10-10 ☐

Figure 7-1 ☐. Retransmission interference chart (part 2 of 2).

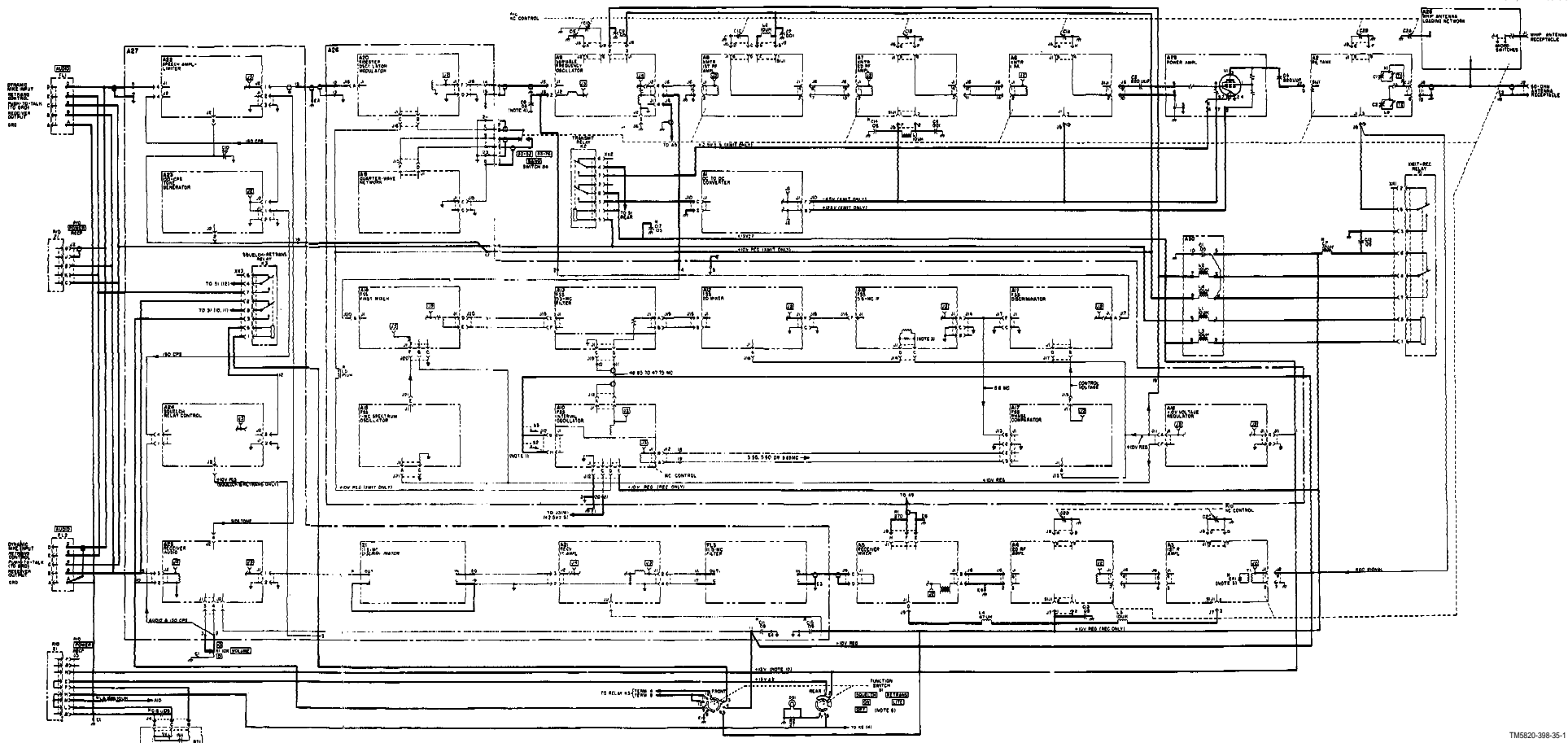
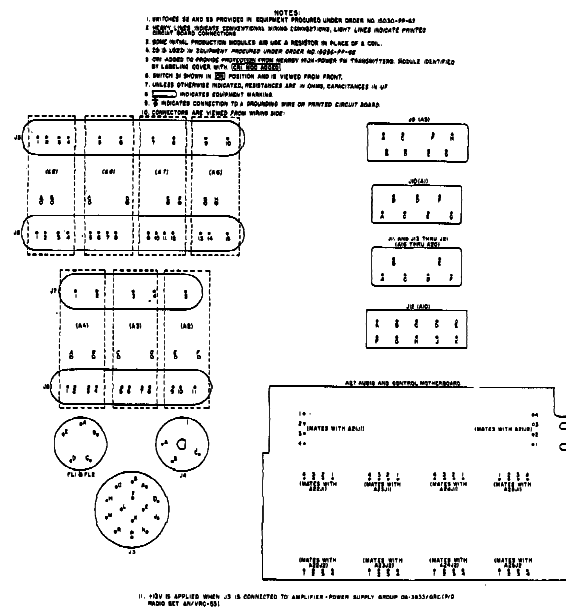

Figure 7-2. Receiver-Transmitter, Radio RT-505-PRC-25, schematic-block diagram



